











DK-LOK

DK-Lok Tube Fittings



Rev. 01-02
Jan. 2024













Tube to Tube Union





Union DU		11
Union Elbow DL		12
Union Tee DT		13
Union Cross DX		14
Bulkhead Union DUB		15
Bulkhead Retainer DBR		16
Bulkhead Elbow Union DBL		16
Reducing Union DUR		17
Reducing Union Elbow DLR		18
Reducing Union Cross DXR		18
Reducing Union Tee DTR		19



Tube to Male Pipe

Male Connector DMC-N		21
		22
Male Connector DMC-R		23
		24
Thermocouple Connector DMCT		23















Male Connector for Bonded Gasket Seal DMC-G		25
Male Connector for Metal Gasket DMC-GB, -G		25 26
Bulkhead Male Connector DMCB-N		28 29
45° Male Elbow DLBM		29
Male Elbow DLM-N		30 31
Male Elbow DLM-R		32 33
Male Run Tee DTRM-N		34
Male Run Tee DTRM-R		35
Male Branch Tee DTBM-N, -R		36
Male Branch Tee DTBM-N		37
Male Branch Tee DTBM-R		38

Tube to Female Pipe

Female Connector DCF-N		39
		40
Female Connector DCF-R		41
Gauge Connector DCF-GG		42
Bulkhead Female Connector DCBF-N		43
Female Elbow DLF-N		44

Female Run Tee DTBF-N		45
Female Branch Tee DTBF-N		46

Tube Stub Connector

Reducer DR		47 48
Bulkhead Adapter DAB		49
Male Adapter DAM-N		49 50
Male Adapter DAM-R		51
Male Adapter DAM-G		52
Male Adapter DAM-U		53
Male Adapter DAM-UO		53
Female Adapter DAF-N		54
Female Adapter DAF-R		55
Female Adapter DAF-GR		55
Female Gauge Adapter DAF-GG		56
Elbow Adapter DLA		57
Run Tee Adapter DTRA		57
Branch Tee Adapter DTBA		57

Port Connector DCP/DCPZ		58
-----------------------------------	---	----

Reducing Port Connector DCRP		59
--	---	----

DK-Lok Flanges

DK-Lok Flanges DF		59 60
-----------------------------	---	----------

Lab Joint Flange Connector DLJ		60
---	---	----

Tube to AN Tube

AN Union DUA		61
------------------------	---	----

AN Bulkhead Union DUBA		61
----------------------------------	--	----

Male AN Adapter DMAA		62
--------------------------------	---	----

AN Adapter DAA		62
--------------------------	---	----

Tube to Non-Positionable O-Seal

O-Seal Straight Thread Connector DMC-UO		63
--	---	----

O-Seal Pipe Thread Connector DMC-NO		63
--	---	----

Non-Positionable SAE Male Connector DMCS-U		64
---	---	----

Tube to Positionable Straight Thread

Positionable SAE Male Elbow DL5-UP		65
---	---	----

Positionable 45° SAE Male Elbow DLBS-UP		66
--	---	----

Positionable SAE Male Run Tee DTRS-UP		66
--	---	----

Positionable SAE Male Branch Tee DTBS-UP		66
---	---	----

Positionable Male Elbow ISO Parallel thread DLM-GP		67
---	---	----

Tube To Weld End

Male Pipe Weld Connector DCW		68
---	---	----

Male Pipe Weld Elbow DLW		69
---------------------------------------	---	----

Tube Socket Weld Connector DCSW		69
--	---	----

Tube Socket Weld Elbow DL5W		70
--	---	----

Welding Bulkhead Union DBUW		70
--	---	----

Plug, Cap, Insert

Plug DP		70
-------------------	---	----

Cap DC		71
------------------	---	----

Tube Insert DI		72
--------------------------	---	----

Additional Products

Fuse Plug DFA		72
-------------------------	---	----

Vent Protector DMD		73
------------------------------	---	----

Calibration Fittings DPCM		73
-------------------------------------	---	----

Dielectric Fittings DEU		74
-----------------------------------	---	----

Sanitary Fitting DSFC		75
---------------------------------	---	----

Chromatography Fitting DCHU		75
---------------------------------------	---	----

Spare Parts

Gasket DGV/DGB DGC/DGG		27
--------------------------------------	---	----

Nut DN		76
------------------	---	----

Ferrule Set DFS		76
---------------------------	---	----

Nut-Ferrule Set DFSN		76
--------------------------------	---	----

Front Ferrule DFF		77
-----------------------------	--	----

Back Ferrule DFB		77
----------------------------	---	----

Tools

Preswaging Tool DPS		77
-------------------------------	---	----

Gap Gauge DIG		78
-------------------------	---	----

Tube Depth Marking Tool DTM		78
--	---	----

Pre-Swaging Unit DHS-2A		78
-----------------------------------	---	----

Pre-Swaging Unit DES-1A		78
-----------------------------------	---	----

Hand Tube Bender DHTB		79
---------------------------------	---	----

Tube Cutter DTC		79
---------------------------	---	----

Tube Deburring Tool DTDT		79
------------------------------------	---	----

The Premium Quality DK-Lok Tube Fittings

DK-Lok Tube Fitting is designed using industrial codes and specifications with additional Cutting-Edge Engineering on swaging action and sealing integrity. DK-Lok provides excellent leak-free sealing on high pressure gas, vacuum, impulse, thermal shock, heavy vibration, and many other stringent applications.

DK-Lok brings you truly excellent quality, outstanding customer service, and availability.

Enjoy DK-Lok tube Fitting working on your application!

Construction of DK-Lok Tube Fittings

DK-Lok Tube Fitting consists of body, front ferrule, back ferrule and nut. The features include;

- Excellent product range up to 2 in. and 50 mm OD.
- Additional engineering on sealing integrity and swaging action.
- Re-usable and predictable quality.
- Gaugable.
- Excellent leak-free sealing integrity on heavy vibration, vacuum and impulse.
- Heat-Code Traceability.
- No torque transferring to connective tubing during installation.

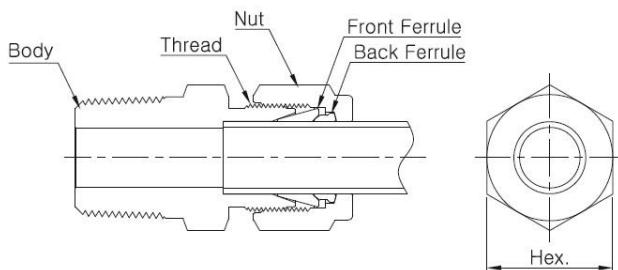

Identification of Metric DK-Lok Tube Fitting

Metric DK-Lok Tube Fitting has stepped shoulder on body and nut hex. Shaped fitting such as tee, elbow, and cross forging has such step on body as well.

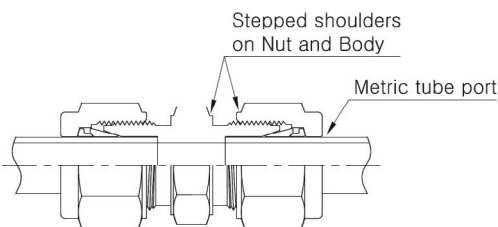

Identification of Metric DK-Lok Tube Fitting

Every DK-Lok Tube Fitting is cleaned to remove surface contamination, iron particles from cutting tools, oil from cutting fluid, and loose particles. For further information refer to DK cleaning standard DC-01.

Special cleaning for oxygen service application is available on request. Refer to special cleaning standard DC-11.

Table 1. DK-Lok Material Standards

DK-Lok Tube Fitting are supplied in various materials to satisfy the needs of various applications including on shore oil&gas, refinery, offshore oil& gas, chemical, petrochemical, analytical instrumentation, steel mill, power plant, shipbuilding, pharmaceutical, and alternative fuel.

Material	Bar stock	Forging
Stainless Steel316	ASTMA276	ASTM A182 ASME SA182 JIS G3214
	ASTMA479	
	ASME SA479	
	JIS G4303	
Brass	ASTM B16 UNS C36000	ASTM B283 UNS C37700 JIS H3250 Alloy C3771
	ASTM B453 UNS C35300	
	JIS H3250Alloy C3604	
Carbon Steel	ASTM A675 Gr.60-90	ASTM A105 JIS G4051 S20C - S48C
	JIS G4051 S20C - S48C	
Duplex	ASTM A276 S31803	ASTM A182 F51
	ASTM A479 S31803	
Super Duplex	ASTM A479 S32750	ASTM A182 F53
Aluminum	ASTM B211 Alloy 2024 T6	ASTM B247
Alloy 20	ASTM B473 UNS N08020	ASTM B462 UNSN08020
Hastelloy C276	ASTM B574 UNS N10276	ASTM B564 UNSN10276
Alloy 400	ASTM B164 UNS N04400	ASTM B564 UNSN04400
Alloy 600	ASTM B166 UNS N06600	ASTM B564 UNSN06600
Alloy 625	ASTM B446 UNS N06625	ASTM B564 UNSN06625
Alloy 825	ASTM B425 UNS N08825	ASTM B564 UNSN08825
Titanium Gr. 2	ASTM B348 Gr.2	ASTM B381 F3
PTFE	ASTM D1710	ASTM D3293

Carbon Steel DK-Lok Tube Fittings



Carbon steel fittings are white zinc plated. Every carbon steel fitting is supplied with SS316 back ferrule and carbon steel front ferrule with black fast plated.

O-ring

DK-Lok fitting pipe end with O-ring is supplied; 70 durometer NBR O-ring on brass and carbon steel fittings, 90 durometer FKM O-ring on stainless steel fitting. Other O-ring is available on request.

DK-Lok Port Dimension

Dimensions on DK-Lok Port in the catalog are approximate figures and shown in finger-tight position.

DK-Lok Port Dimension

Stainless steel316 DK-Lok Tube Fittings are tested to the requirements of ECE R110, DIHP Draft, ECE R67 and certified by TUV.

Tubing

For safe, reliable and leak-free DK-Lok fitting system, tubing should be considered as one of fitting components.

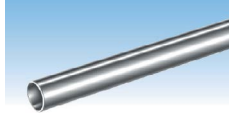

- Tubing is assembled by simple wrench make-up on DK-Lok fitting. This results in less assembly and maintenance costs.
- Tubing assembly on DK-Lok Fitting is re-usable.
- Tubing is bendable. It allows lower pressure drop with fewer connections. This in turn reduces system costs because of less fabricating manpower
- Pipe threading or welding is difficult to disassemble and re-assemble.
- Piping requires skilled worker for welding & threading.

Tubing Selection

Hardness

- Tubing must be softer than fitting material. The metal tubing must be fully annealed and suitable for bending and flaring.
- Tubing hardness must be selected according to the information in the table 2 to 13.

Surface

- Tubing must have a surface free from scratches, draw mark, dirt, dust and at spots.

Ovality

- Tubing in oval or out-of-roundness way not fit into the fitting. Do not force the tubing into the fitting; it may damage the fitting sealing system on nut, ferrules, and body.

Wallthickness

- The table 2 to 13 list tubing working pressure ratings in a wide range of wall thickness. A too thin wall may collapse and a too thick wall may not properly be deformed by the ferrule action.
- Do not use tubing wall thickness not listed in the table 2 to 13.

Weld tubing

- Welded tubing should have a not measurable bead on its outside diameter.

Tubing Handling

Careful handling and storage practices will protect tubing from unnecessary scratches, nicks, or degrading the good tubing surface finish.

- Tubing ends should be capped so any foreign materials will not fall inside during transportation and storage.
- Do not drag across tubing rack, cement, gravel or any rough surface.
- Do use correct tube cutter for tube material. The wrong cutter may result in excessive deformation of the tube end.
- Do not cut deep with each turn of cutting.
- Tube cutters and hacksaws should be sharp enough.
- Hacksaw blades should have at least 32 teeth per inch.
- Do deburr tube ends before inserting in fittings.

DK-Lok Tube Fitting Pressure Rating

- The pressure rating of DK-Lok Tube Fitting is rated to the working pressure of connective tubing.
- The allowable working pressure of tubing in various materials is listed in the table 2 to 13.

Material

Using like tubing and fitting material is essential for leak-free sealing system.

Unlike material may have different mechanical properties that may adversely affect the fitting seal on tubing. The only exception is copper tubing with brass DK-Lok fitting.

Gas Application

DK-Lok Tube Fitting is designed for a wide rang of leak-free application including gas leak proof and vacuum tight service.

Gases (helium, hydrogen, nitrogen, air, etc.) can escape even the most minute leak-path due to their very small molecules.

Tube therefore must be handled not to have scratches, draw mark, nicks, flat sports, dirt, and dust

Use NOT thin wall tubing for gas applications.

Heavier wall tubing resists the ferrule action whereas thin walltubing may collapse with little resistance to ferrule action.

For Gas service, use the tubing wall listed on un-shadowed section in table 2 to 13.

Vacuum Application

DK-Lok Tube Fittings have been proved to be excellent vacuum tight seal in many applications including analytical industry.

DK-Lok Tube Fittings comply with the leakage requirements of TA-LUFT 2002.

Cryogenic Application

DK-Lok Fittings in SS316 Stainless Steel provide highly reliable performance on cryogenic application.

Cryogenic temperature is considered to be temperatures below -100°F (-73°C).

Cryogenic Application

Pressure 500 psig (34.5 bar) or higher is considered generally high pressure. In the high pressure system scratches, draw mark, nicks, flat sports, and dirt on tubing may cause leakage.

- For gas application, select the gas applicable tubing wall thickness from Table 2 to 13.
- Follow the suggestion on tubing selection, handling, and installation.

Stainless Steel Tubing

Table 2. Fractional Seamless Stainless Steel Tubing

Fully annealed austenitic Type 304 or 316 seamless tubing ASTM A269 or ASTM A213, or equivalent. Tubing to be free from scratches, draw mark, dirt, dust, flat spots, and suitable for bending and flaring. Recommended hardness: 90 HRB or less.

OD in.	Wall Thickness (in.)																		
	0.012	0.014	0.016	0.02	0.028	0.035	0.049	0.065	0.083	0.095	0.109	0.12	0.134	0.156	0.188				
1/16	6800	8100	9400	12000															
1/8					8500	10900													
3/16					5400	7000	10200												
1/4					4000	5100	7500	10200											
5/16						4000	5800	8000											
3/8							3300	4800	6500	7500									
1/2								2400	3500	4700	6200								
5/8									2900	4000	5200	6000							
3/4										2400	3300	4200	4900	5800					
7/8											2000	2800	3600	4200	4800				
1												2400	3100	3600	4200	4700			
1 1/4													2400	2800	3300	3600	4100	4900	
1 1/2														2300	2700	3000	3400	4000	4900
2															2000	2200	2500	2900	3600

Table 3. Metric Seamless Stainless Steel Tubing

OD mm	Wall Thickness (mm)													
	0.8	1.0	1.2	1.5	1.8	2.0	2.2	2.5	2.8	3.0	3.5	4.0	4.5	
3	710													
6	330	420	520	670										
8		310	380	490										
10		240	300	380										
12		200	240	310	380	430								
14		180	220	280	340	390	430							
15		170	200	260	320	360	400							
16			190	240	300	330	370							
18			170	210	260	290	320	370						
20			150	190	230	260	290	330	380					
22			130	170	210	230	260	300	340					
25					180	200	230	260	300	320				
28						180	200	230	260	280	330			
30						170	190	210	240	260	310			
32						160	170	200	230	240	290	330		
38							140	170	190	200	240	280	310	
50										150	180	210	240	

- According to the requirements of ASME B31.3 Process Piping Code and ASME B31.1 Power Piping Code, allowable working pressure calculated at -20 to 100°F (-28 to 37°C) using S value of 20,000 psi.
- Pressure calculations are based on maximum O.D. and minimum wall thickness and no allowance is made for corrosion and erosion. i.e., ASTM A269 1/2 in. OD x 0.035 in. WT: OD tolerance ± 0.005 in., WT tolerance ± 15%. Calculations are based on 0.505 in. OD x 0.0298 in. WT.
- Safety Factor is 3.75 to 1, considering ultimate tensile strength of 75,000 psi.

Weld Stainless Steel Tubing Allowable Working Pressure

To determine the working pressure of weld tubing to the requirements of ASME B31.3 Code, de-rating factors below must be applied. For single weld tubing multiply by 0.80, and for double weld tubing multiply by 0.85.

Example: SS316 seamless 1/2 in. O.D. x 0.065 in. WT allowable working pressure: 4700 psi.
 To determine the work pressure of the single weld tubing, multiply 4700 psi by 0.80.
 4700 psig x 0.80 = 3760 psig at -20 to 100°F (-28 to 37°C).

Copper Tubing

Table 4. Fractional Seamless Copper Tubing

Soft annealed seamless copper tubing ASME B75 or equivalent. Soft annealed (Temper 0) copper water tube, type K or Type L to ASTM B88. Recommended hardness: 60 HRB or less.

OD in.	Wall Thickness (in.)									
	0.010	0.012	0.028	0.035	0.049	0.065	0.083	0.095	0.109	0.120
1/8			2700	3600						
3/16			1800	2300	3400					
1/4			1300	1600	2500	3500				
5/16				1300	1900	2700				
3/8				1000	1600	2200				
1/2				800	1100	1600	2100			
5/8					900	1200	1600	1900		
3/4					700	1000	1300	1500	1800	
7/8					600	800	1100	1300	1500	
1					500	700	900	1100	1300	1500

Table 5. Metric Seamless Copper Tubing

OD mm	Wall Thickness (mm)									
	0.7	0.8	1.0	1.2	1.5	1.8	2.0	2.2	2.5	
3	225	260								
4	165	191	244	295						
6		122	157	192	245					
8			114	140	179					
10			89	109	140					
12			73	89	114	140	158			
14			62	76	96	118	133			
16					83	102	114	127	147	
18					74	90	101	112	129	
22					59	72	81	90	103	
25					52	63	71	78	90	

- According to the requirements of ASME B31.3 Process Piping Code and ASME B31.1 Power Piping Code, allowable working pressure calculated at -20 to 100°F (-28 to 37°C) using S value of 6000 psi.
- Safety Factor is 5 to 1, considering ultimate tensile strength of 30,000 psi.

Carbon Steel Tubing

Table 6. Fractional Seamless Carbon Steel Tubing

Soft annealed seamless carbon steel hydraulic tubing ASTM A179 or equivalent. Tubing to be free from scratches, draw mark, dirt, dust, flat spots, and suitable for bending and flaring. Recommended hardness: 72 HRB or less.

OD in.	Wall Thickness (in.)												
	0.028	0.035	0.049	0.065	0.083	0.095	0.109	0.120	0.134	0.148	0.165	0.180	0.220
1/8	8000	10200											
3/16	5100	6600	9600										
1/4	3700	3700	7000	9600									
5/16		3800	5500	7600									
3/8		3100	4500	6200									
1/2		2300	3300	4500	5900								
5/8		1800	2600	3500	4600	5300							
3/4			2100	2900	3700	4300	5100						
7/8			1800	2400	3200	3700	4300						
1			1500	2100	2700	3200	3700	4100					
1 1/4				1600	2100	2500	2900	3200	3600	4000	4600	5000	
1 1/2					1800	2000	2400	2600	3000	3300	3700	4100	5100
2						1500	1700	1900	2200	2400	2700	3000	3700

Table 7. Metric Seamless Carbon Steel Tubing

OD mm	Wall Thickness (mm)												
	0.8	1.0	1.2	1.5	1.8	2.0	2.2	2.5	2.8	3.0	3.5	4.0	4.5
3	670	830											
6	310	400	490	630									
8		290	360	460									
10		230	280	360									
12		190	230	290	360	410	450						
14		160	190	250	300	340	380						
15		150	180	230	280	320	350						
16			170	210	260	290	330	380					
18			150	190	230	260	290	330					
20			130	170	200	230	250	290	330				
22			120	150	180	210	230	260	300				
25					160	180	200	230	260	280			
28						160	180	200	230	250	290		
30						150	160	190	210	230	270		
32						140	150	170	200	210	250	290	
38							130	140	160	180	210	240	280

- Allowable working pressure calculated at -20 to 100°F (-28 to 37°C) using S value of 15,700 psi according to ASME B31.3 Process Piping Code.
- Safety Factor is 3 to 1, considering ultimate tensile strength of 47,000 psi.
- To determine working pressure of ASME B31.1 Power Piping Code, multiply the ASME B31.3 rating by 0.85

Table 8. Fractional Seamless Alloy 400 Tubing

Fully annealed seamless Alloy 400 Tubing ASTM B165 or equivalent. Tubing to be free from scratches, draw mark, dirt, dust, at spots, and suitable for bending and aring. Recommended hardness: 75 HRB or less.

OD in.	Wall Thickness (in.)							
	0.028	0.035	0.049	0.065	0.083	0.095	0.109	0.120
1/8	7900	10100						
1/4	3700	4800	7000	9500				
3/8		3100	4400	6100				
1/2		2300	3200	4400				
3/4			2200	3000	4000	4600		
1				2200	2900	3400	3900	4300

- According to the requirements of ASME B31.3 Process Piping Code and ASME B31.1 Power Piping Code, allowable working pressure calculated at -20 to 100°F (-28 to 37°C) using S value of 18,700 psi.
- Safety Factor is 3.74 to 1, considering ultimate tensile strength of 70,000 psi.

Table 9. Fractional Seamless Alloy C276 Tubing

Fully annealed seamless Alloy C276 Tubing ASTM B622 or equivalent. Tubing to be free from scratches, draw mark, dirt, dust, at spots, and suitable for bending and aring. Recommended hardness: 100 HRB or less.

OD in.	Wall Thickness (in.)			
	0.028	0.035	0.049	0.065
1/4	4000	5100	7500	10200
5/16		4000	5800	7800
3/8		3300	4800	6500
1/2		2600	3700	5100

- According to the requirements of ASME B31.3 Process Piping Code and ASME B31.1 Power Piping Code, allowable working pressure calculated at ambient temperature using S value of 27,300 psi.
- Safety Factor is 3.66 to 1, considering ultimate tensile strength of 100,000 psi.

* Working Pressure in psig

Table 10. Fractional Seamless Alloy 825 Tubing

Fully annealed seamless Alloy 825 Tubing ASTM B423 or equivalent. Tubing to be free from scratches, draw mark, dirt, dust, at spots, and suitable for bending and aring. Recommended hardness: 95 HRB or less.

OD in.	Wall Thickness (in.)		
	0.035	0.049	0.065
1/4	6400	9300	11600
3/8	4100	5900	8200
1/2	3000	4300	5900

- According to the requirements of ASME B31.3 Process Piping Code and ASME B31.1 Power Piping Code, allowable working pressure calculated at ambient temperature using S value of 23,300 psi.
- Safety Factor is 3.64 to 1, considering ultimate tensile strength of 85,000 psi.

* Working Pressure in psig

Table 11. Fractional Seamless Alloy 625 Tubing

Fully annealed seamless Alloy 625 Tubing ASTM B444 Grade 1 or equivalent. Tubing to be free from scratches, draw mark, dirt, dust, flat spots, and suitable for bending and flaring.

OD in.	Wall Thickness (in.)		
	0.035	0.049	0.065
1/4	7300	10700	14600
3/8	4700	6800	9400
1/2	3500	5000	6800

* Working Pressure in psig

- Allowable working pressure is calculated at ambient temperature using S value of 40,000 psi according to ASME B31.3 Code.
- Safety Factor is 3 to 1, considering ultimate tensile strength of 120,000 psi.
- To determine working pressure of ASME B31.1 Power Piping Code, multiply the ASME B31.3 rating by 0.86.

Table 12. Fractional Seamless Super Duplex Tubing

Fully annealed Super Duplex Tubing ASTM A789 S32750 or equivalent. Tubing to be free from scratches, draw mark, dirt, dust, at spots, and suitable for bending and aring. Recommended hardness: 32 HRC or less.

OD in.	Wall Thickness (in.)				
	0.035	0.049	0.065	0.083	0.095
1/4	10000	15000			
3/8	6500	10100	12700		
1/2	5000	7200	10100	12900	
5/8		5800	7600	10100	
3/4		4700	6300	8500	10000

* Working Pressure in psig

- Allowable working pressure calculated at ambient temperature using S value of 38,700 psi according to ASME B31.3 Code.
- Safety Factor is 3 to 1, considering ultimate tensile strength of 116,000 psi.

Table 13. Fractional Seamless Alloy 20 Tubing

Fully annealed seamless Alloy 20 Tubing ASTM B729 or equivalent. Tubing to be free from scratches, draw mark, dirt, dust, flat spots, and suitable for bending and flaring. Recommended hardness: 95 HRB or less.

OD in.	Wall Thickness (in.)			
	0.028	0.035	0.049	0.065
1/8	Working Pressure in psig			
3/16				
1/4	4500	5100	7500	10200
5/16				
3/8		3300	4800	6500
1/2		2600	3700	5100

* Working Pressure in psig

- Allowable working pressure calculated at ambient temperature using S value of 23,300 psi according to ASME B31.3 Process Piping Code.
- To determine working pressure of ASME B31.1 Power Piping Code, multiply the ASME B31.3 rating by 0.98.

Temperature De-rating Factors

The pressure rating of DK-Lok port is governed by the connective tubing pressure rating. To determine allowable working pressure at elevated temperature, multiply working pressure by applicable factor shown in table 14.

Example: SS316 seamless tubing 1/2 in. O.D. x 0.065 in.WT at 700 °F. 4700 psig x 0.82 = 3854 psi.
 Allowable working pressure of SS316 seamless 1/2 in. O.D. x 0.065 in. WT is 3854 psi at 700 °F.

Table 14.









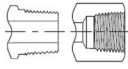
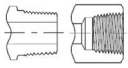

Temp.		Stainless		C.steel	Copper	825	C276	625	20	400	Super Duplex
°F	°C	304	316	A179	B75	B423	B622	B444	B729	B165	A789
100	38	1	1	1	1	1	1	1	1	1	1
200	93	1	1	0.96	0.8	0.92	1	1	0.9	0.88	0.9
300	149	1	1	0.9	0.78	0.87	1	1	0.86	0.79	0.85
400	204	0.94	0.97	0.86	0.5	0.83	1	1	0.83	0.79	0.82
500	260	0.88	0.9	0.82	0.13	0.79	0.98	0.97	0.79	0.79	0.81
600	316	0.82	0.85	0.77		0.76	0.93	0.95	0.77	0.79	0.8
700	371	0.8	0.82	0.73		0.74	0.87	0.93	0.76	0.79	
800	427	0.76	0.8	0.59		0.73	0.84	0.93	0.73	0.76	
900	482	0.73	0.78			0.73	0.81	0.93			
1000	538	0.69	0.77			0.71	0.79	0.93			
1200	649	0.3	0.37				0.35	0.33			

DK-Lok Pipe End Pressure Rating

Pressure ratings of DK-Lok tube port is governed by the connective tubing pressure rating. The allowable working pressure of those fittings with both DK-Lok port and pipe end port are determined by the lower pressure port.

Table 15. DK-Lok Pipe Thread Designator

Legends • DK: DK-Lok pipe thread designator. • E: Equivalent.

	DK	Reference Specification	Thread Configuration	E
Tapered Pipe Thread	N	ASME B1.20.1 (NPT) SAE AS71051		
	R	ISO 7-1 BS EN 10226-1 (BSPT) DIN 2999 (male thread only) JIS B0203 (PT)		RT
Parallel Pipe Thread	G	ISO 228-1 BS 2779 (BSPP) JIS B0202 (PF) DIN 3852 FORM A		RS
	GB	ISO 228-1 BS 2779 (BSPP) JIS B0202 (PF) DIN 3852 FORM B		RP
	GP	ISO 228-1 BS 2779 (BSPP) JIS B0202 (PF) SAE J475 SAE J1926		PR
Parallel Pipe Thread	GG	ISO 228-1 BS 2779 (BSPP) JIS B0202 (PF) EN 837-1& EN 837-3		RG
	GR	ISO 228-1 BS 2779 (BSPP) JIS B0202 (PF) DIN 3852 FORM Z		RP
	GY	ISO 228-1 BS 2779 (BSPP) JIS B0202 (PF) DIN 3852 FORM Y		RJ
SAE Straight Thread	U	ASME B1.1 ISO R725 SAE J475 SAE J514		SR
	UO	ASME B1.1 ISO R725 SAE J475 SAE J514		OR
	UP	ASME B1.1, ISO R725 SAE J475 SAE J514		ST
	NO	ASME B1.20.1, SAE AS71051 SAE J514		OR

Pipe Thread Sealants

Pipe thread sealant for tapered pipe thread assembly is essential to ensure leak-free thread sealing. Sealant usually contains a lubricant. Thread sealant fills the voids between the threads and prevents thread galling.

Wrap PTFE tape clockwise from first thread. Do not overhang the first thread; the tape may get into the fluid system.

Pressure Equivalents:
 1 bar = 100 kPa = 14.503 psi 1 kPa = 0.01 bar = 0.145 psi
 1 psi = 0.069 bar = 6.89 kPa 1 kg/Cm2 = 0.98 bar = 14.22 psi

Table 16. Tapered Pipe Thread Pressure Ratings

Applicable to DK-Lok thread designator: N and R

ISO/NPT Pipe Size	SS316 and Carbon Steel				Brass			
	Male		Female		Male		Female	
	psig	bar	psig	bar	psig	bar	psig	bar
S value	20ksi				10ksi			
1/16	14000	965	6600	455	7400	510	3300	227
1/8	10000	689	6400	441	5000	345	3200	220
1/4	8300	572	6500	448	4100	282	3200	220
3/8	8000	551	5200	358	4000	275	2600	179
1/2	7800	537	4800	331	3900	269	2400	165
3/4	7500	517	4600	317	3700	255	2300	158
1	5300	365	4400	303	2600	179	2200	152
1 1/4	6200	427	5000	345	3100	214	2500	172
1 1/2	5100	351	4500	310	2500	172	2200	152
2	4000	276	3900	269	2000	138	1900	131

Allowable Working Pressure

DK-Lok ISO Parallel Male Pipe Thread End

Applicable to DK-Lok thread designator: G, GB, and GP. SS316 and carbon steel fitting thread ends up to 1 in. are rated to 5900 psi (406 bar)

DK-Lok SAE Straight Thread End

Applicable to DK-Lok thread designator: U, UO, and UP. SS316 and carbon steel fitting thread ends up to 1 5/16-12 are rated to 6000 psi (413 bar)

DK-Lok Tube Socket Weld End

Applicable to DK-Lok tube fitting part number: DCSW and DLSW. SS316 and carbon steel fitting tube socket ends up to 1/2 in. (-8) are rated to 7,000 psi (482 bar)

DK-Lok Pipe Butt Weld End

Applicable to DK-Lok tube fitting part number: DCW and DLW. SS316 and carbon steel fitting pipe butt weld ends up to 3/4 in. (-12P) are rated to 6,000 psi (413 bar)

- Pressure ratings are based on ASME B31.3 Process Piping Code, at ambient temperature.
- For further information about each size end rating, contact the authorized DK-Lok distributor in your region.

Table 17. Elastomer seal temperature ratings

Elastomer O-ring	Rating
NBR	-40 to 110°C (-40 to 230°F)
FKM	-28 to 204°C (-18 to 400°F)
FFKM (Kalrez®)	-30 to 275°C (-22 to 527°F)

Care must be taken as fitting with elastomer O-ring seal may have lower temperature rating. Kalrez®: Dupont™

Ordering Information

Suffix the material designator to the part number. Example: DU-8-S

Table 18. Material Designator

Material	Designator
Stainless Steel 316	S
Dual Grade	
Brass	B
Carbon Steel	C
Stainless 310	310
Duplex	D
Super Duplex	SD
Aluminum	AL
Alloy 20	L20
Hastelloy C276	HC
Alloy 400	M
Alloy 600	IN
Alloy 625	L625
Alloy 825	L825
Titanium Gr. 2	TI
PTFE	PE

Tee and Cross Fittings

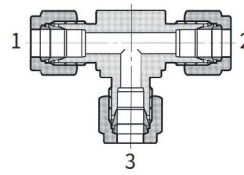

Tee fitting part number is described by first the run (1 and 2) and next the branch (3).

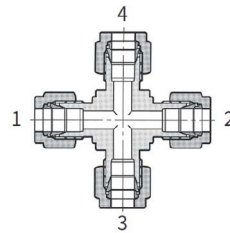

Cross fitting part number is described by first the run (1 and 2) and next the branch (3 and 4)

Table 19. Pipe Thread Size Designator

	1/16	1/8	1/4	3/8	1/2	3/4	1	1-1/4	1-1/2	2
Designator	1	2	4	6	8	12	16	20	24	32

Table 20. Tube O.D. Designator

OD in.	1/16	1/8	3/16	1/4	5/16	3/8	1/2	5/8	3/4	7/8	1	1 1/4	1 1/2	2		
Designator	1	2	3	4	5	6	8	10	12	14	16	20	24	32		
OD mm	2mm	3mm	4mm	6mm	8mm	10mm	12mm	16mm	20mm	22mm	25mm	28mm	32mm	38mm	42mm	50mm
Designator	2M	3M	4M	6M	8M	10M	12M	16M	20M	22M	25M	28M	32M	38M	42M	50M

Z series DK-Lok

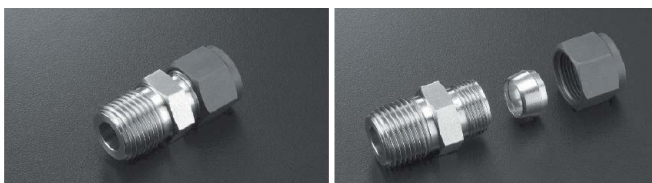

DK-Lok Z Series single ferrule tube fitting is designed and manufactured to the highest quality standards. This fitting includes single ferrule with standard DK-Lok fitting body and nut. To help identify DK-Lok Z series from DK-Lok Tube fitting, nut is black Molybdenum Disulfide (MoS₂) coated.

Material

DK-Lok Z Series single ferrule tube fitting is manufactured in stainless steel 316.

Dimensions

DK-Lok Z Series fittings are dimensionally identical to DK-Lok Tube Fittings.

Pressure and Temperature Ratings

DK-Lok Z Series fittings are identical to DK-Lok Tube Fittings in pressure and temperature ratings.

Ordering Information

To order Z series, insert Z in the standard DK-Lok tube fitting part number. Examples: DUZ-8-S, DMCZ8-8N-S, DNZ-4-S

Z Series Ferrule

Part No.	Tube O.D.
DFZ-4-S	1/4
DFZ-6-S	3/8
DFZ-8-S	1/2
DFZ-12-S	3/4
DFZ-16-S	1

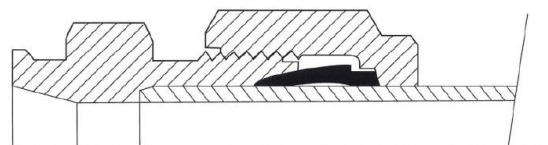
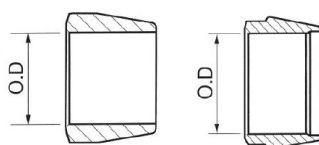

Union
DU

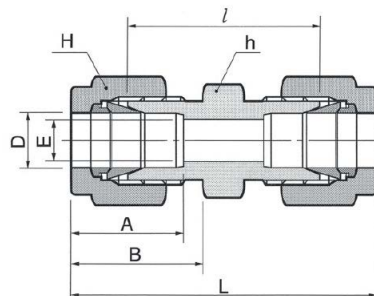

Connects fractional tube

Part No.	Tube O.D. D		E Min.	Width across flat				A	B	e	L
	in.	mm		h		H					
				in.	mm	in.	mm				
DU-1	1/16	1.59	1.27	5/16	7.93	5/16	7.93	8.63	10.92	17.50	25.15
DU-2	1/8	3.17	2.28	7/16	11.11	7/16	11.11	12.70	15.24	22.35	35.56
DU-3	3/16	4.76	3.04	7/16	11.11	1/2	12.70	13.71	16.00	24.13	37.33
DU-4	1/4	6.35	4.82	1/2	12.70	9/16	14.28	15.24	17.78	26.16	40.89
DU-5	5/16	7.93	6.35	9/16	14.28	5/8	15.87	16.25	18.54	28.19	42.92
DU-6	3/8	9.52	7.11	5/8	15.87	11/16	17.46	16.76	19.30	30.22	44.95
DU-8	1/2	12.70	10.41	13/16	20.64	7/8	22.22	22.86	21.84	30.98	51.30
DU-10	5/8	15.87	12.70	15/16	23.81	1	25.40	24.38	21.84	31.75	52.07
DU-12	3/4	19.05	15.74	1-1/16	26.98	1-1/8	28.58	24.38	21.84	33.27	53.59
DU-14	7/8	22.22	18.28	1-3/16	30.16	1-1/4	31.75	25.90	21.84	35.05	55.37
DU-16	1	25.40	22.35	1-3/8	34.92	1-1/2	38.10	31.24	26.41	40.38	64.77
DU-20	1-1/4	31.75	27.68	1-3/4	44.45	1-7/8	47.63	41.14	38.86	48.00	92.20
DU-24	1-1/2	38.10	33.90	2-1/8	53.97	2-1/4	57.15	50.03	45.21	53.60	107.95
DU-32	2	50.80	45.97	2-3/4	69.85	3	76.20	67.56	62.73	74.70	149.35

Connects metric tube

Part No.	Tube O.D. D	E Min.	Width across flat		A	B	e	L
			h	H				
DU-2M	2	1.7	12	12	12.9	15.3	22.4	35.6
DU-3M	3	2.4	12	12	12.9	15.3	22.1	35.3
DU-4M	4	2.4	12	12	13.7	16.1	24.1	37.3
DU-6M	6	4.8	14	14	15.3	17.7	26.2	41.0
DU-8M	8	6.4	15	16	16.2	18.6	28.2	43.2
DU-10M	10	7.9	18	19	17.2	19.5	31.0	46.2
DU-12M	12	9.5	22	22	22.8	22.0	31.0	51.2
DU-14M	14	11.1	24	25	24.4	22.0	31.8	52.0
DU-15M	15	11.9	24	25	24.4	22.0	31.8	52.0
DU-16M	16	12.7	24	25	24.4	22.0	31.8	52.0
DU-18M	18	15.1	27	30	24.4	22.0	33.3	53.5
DU-20M	20	15.9	30	32	26.0	22.0	34.8	55.0
DU-22M	22	18.3	30	32	26.0	22.0	34.8	55.0
DU-25M	25	21.8	35	38	31.3	26.5	40.4	65.0
DU-28M	28	21.8	41	46	36.6	36.6	43.4	85.0
DU-30M	30	26.2	46	50	39.7	39.3	49.5	92.9
DU-32M	32	28.6	46	50	42.0	41.6	51.3	97.3
DU-35M	35	31.5	50	55	42.1	41.7	51.3	97.6
DU-38M	38	33.7	55	60	49.4	47.9	58.4	113.6
DU-42M	42	36.8	60	65	49.3	47.8	58.4	113.4
DU-50M	50	45.2	70	76	67.2	62.5	74.7	149

Union DL

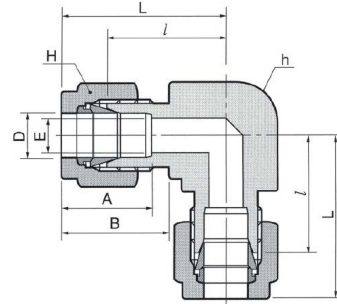

Connects fractional tube

Part No.	Tube O.D. D		E Min.	Width across flat				A	B	ℓ	L
	in.	mm		h		H					
				in.	mm	in.	mm				
DL-1	1/16	1.59	1.27	3/8	9.52	5/16	7.93	8.63	10.92	14.00	17.88
DL-2	1/8	3.17	2.28	3/8	9.52	7/16	11.11	12.70	15.24	15.74	22.35
DL-3	3/16	4.76	3.04	1/2	12.70	1/2	12.70	13.71	16.00	17.78	24.38
DL-4	1/4	6.35	4.82	1/2	12.70	9/16	14.28	15.24	17.78	19.55	26.92
DL-5	5/16	7.93	6.35	9/16	14.28	5/8	15.87	16.25	18.54	21.33	28.70
DL-6	3/8	9.52	7.11	5/8	15.87	11/16	17.46	16.76	19.30	23.11	30.48
DL-8	1/2	12.70	10.41	13/16	20.64	7/8	22.22	22.86	21.84	25.90	36.06
DL-10	5/8	15.87	12.70	15/16	23.81	1	25.40	24.38	21.84	28.70	38.80
DL-12	3/4	19.05	15.74	1-1/16	26.98	1-1/8	28.58	24.38	21.84	29.71	39.87
DL-14	7/8	22.22	18.28	1-3/8	34.92	1-1/4	31.75	25.90	21.84	34.54	44.70
DL-16	1	25.40	22.35	1-3/8	34.92	1-1/2	38.10	31.24	26.41	36.83	49.02
DL-20	1-1/4	31.75	27.68	1-11/16	42.86	1-7/8	47.63	41.14	38.86	44.50	66.54
DL-24	1-1/2	38.10	33.90	2	50.80	2-1/4	57.15	50.03	45.21	50.80	77.97
DL-32	2	50.80	45.97	2-3/4	69.85	3	76.20	67.56	62.73	69.80	107.18

Connects metric tube

Part No.	Tube O.D. D	E Min.	Width across flat		A	B	ℓ	L
			h	H				
DL-2M	2	1.7	9.5	12	12.9	15.3	15.7	22.3
DL-3M	3	2.4	9.5	12	12.9	15.3	15.7	22.3
DL-4M	4	2.4	12.7	12	13.7	16.1	18.8	25.4
DL-6M	6	4.8	12.7	14	15.3	17.7	19.6	27.0
DL-8M	8	6.4	14.3	16	16.2	18.6	21.3	28.8
DL-10M	10	7.9	17.5	19	17.2	19.5	23.9	31.5
DL-12M	12	9.5	20.6	22	22.8	22.0	25.9	36.0
DL-15M	15	11.9	25.4	25	24.4	22.0	28.7	38.8
DL-16M	16	12.7	25.4	25	24.4	22.0	28.7	38.8
DL-18M	18	15.1	27.0	30	24.4	22.0	29.7	39.8
DL-20M	20	15.9	34.92	32	26.0	22.0	32.5	42.6
DL-22M	22	18.3	34.92	32	26.0	22.0	32.5	42.6
DL-25M	25	21.8	34.92	38	31.3	26.5	36.8	49.1
DL-28M	28	21.8	41.0	46	36.6	36.6	43.2	64.0
DL-32M	32	28.6	46.0	50	42.0	41.6	49.3	72.3
DL-38M	38	33.7	50.8	60	49.4	47.9	56.4	84.0
DL-42M	42	36.8	60	65	49.3	47.8	55	82.5
DL-50M	50	45.2	70	76	67.2	62.5	69.9	107

Union Tee
DT

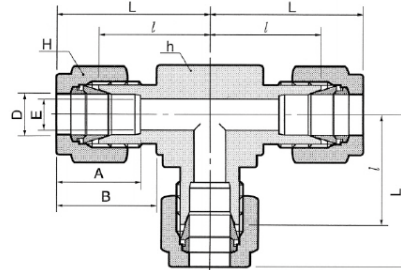

Connects fractional tube

Part No.	Tube O.D. D		E Min.	Width across flat				A	B	ℓ	L
	in.	mm		h		H					
				in.	mm	in.	mm				
DT-1	1/16	1.59	1.27	3/8	9.52	5/16	7.93	8.63	10.92	14.00	17.88
DT-2	1/8	3.17	2.28	3/8	9.52	7/16	11.11	12.70	15.24	15.74	22.35
DT-3	3/16	4.76	3.04	1/2	12.70	1/2	12.70	13.71	16.00	17.78	24.38
DT-4	1/4	6.35	4.82	1/2	12.70	9/16	14.28	15.24	17.78	19.55	26.92
DT-5	5/16	7.93	6.35	9/16	14.28	5/8	15.87	16.25	18.54	21.33	28.70
DT-6	3/8	9.52	7.11	5/8	15.87	11/16	17.46	16.76	19.30	23.11	30.48
DT-8	1/2	12.70	10.41	13/16	20.64	7/8	22.22	22.86	21.84	25.90	36.06
DT-10	5/8	15.87	12.70	15/16	23.81	1	25.40	24.38	21.84	28.70	38.80
DT-12	3/4	19.05	15.74	1-1/16	26.98	1-1/8	28.58	24.38	21.84	29.71	39.87
DT-14	7/8	22.22	18.28	1-3/8	34.92	1-1/4	31.75	25.90	21.84	34.54	44.70
DT-16	1	25.40	22.35	1-3/8	34.92	1-1/2	38.10	31.24	26.41	36.83	49.02
DT-20	1-1/4	31.75	27.68	1-11/16	42.86	1-7/8	47.63	41.14	38.86	44.50	66.54
DT-24	1-1/2	38.10	33.90	2	50.80	2-1/4	57.15	50.03	45.21	50.80	77.97
DT-32	2	50.80	45.97	2-3/4	69.85	3	76.20	67.56	62.73	69.80	107.18

Connects metric tube

Part No.	Tube O.D. D	E Min.	Width across flat		A	B	ℓ	L
			h	H				
DT-2M	2	1.7	9.5	12	12.9	15.3	15.7	22.3
DT-3M	3	2.4	9.5	12	12.9	15.3	15.7	22.3
DT-4M	4	2.4	12.7	12	13.7	16.1	18.8	25.4
DT-6M	6	4.8	12.7	14	15.3	17.7	19.6	27.0
DT-8M	8	6.4	14.3	16	16.2	18.6	21.3	28.8
DT-10M	10	7.9	17.5	19	17.2	19.5	23.9	31.5
DT-12M	12	9.5	20.6	22	22.8	22.0	25.9	36.0
DT-15M	15	11.9	25.4	25	24.4	22.0	28.7	38.8
DT-16M	16	12.7	25.4	25	24.4	22.0	28.7	38.8
DT-18M	18	15.1	27.0	30	24.4	22.0	29.7	39.8
DT-20M	20	15.9	34.92	32	26.0	22.0	32.5	42.6
DT-22M	22	18.3	34.92	32	26.0	22.0	32.5	42.6
DT-25M	25	21.8	34.92	38	31.3	26.5	36.8	49.1
DT-28M	28	21.8	41.0	46	36.6	36.6	43.2	64.0
DT-32M	32	28.6	46.0	50	42.0	41.6	49.3	72.3
DT-38M	38	33.7	50.8	60	49.4	47.9	56.4	84.0
DT-42M	42	36.8	60	65	49.3	47.2	55	82.5
DT-50M	50	45.2	70	76	67.2	62.5	69.9	107

Union DX

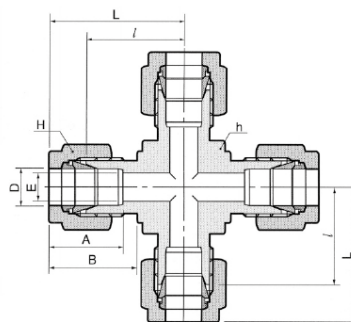

Note : Cross may be made out of bar stock.

Connects fractional tube

Part No.	Tube O.D. D		E Min.	Width across flat				A	B	ℓ	L
	in.	mm		h		H					
				in.	mm	in.	mm				
DX-1	1/16	1.59	1.27	3/8	9.52	5/16	7.93	8.63	10.92	14.00	17.88
DX-2	1/8	3.17	2.28	3/8	9.52	7/16	11.11	12.70	15.24	15.74	22.35
DX-3	3/16	4.76	3.04	1/2	12.70	1/2	12.70	13.71	16.00	17.78	24.38
DX-4	1/4	6.35	4.82	1/2	12.70	9/16	14.28	15.24	17.78	19.55	26.92
DX-5	5/16	7.93	6.35	9/16	14.28	5/8	15.87	16.25	18.54	21.33	28.70
DX-6	3/8	9.52	7.11	5/8	15.87	11/16	17.46	16.76	19.30	23.11	30.48
DX-8	1/2	12.70	10.41	13/16	20.64	7/8	22.22	22.86	21.84	25.90	36.06
DX-10	5/8	15.87	12.70	15/16	23.81	1	25.40	24.38	21.84	28.70	38.80
DX-12	3/4	19.05	15.74	1-1/16	26.98	1-1/8	28.58	24.38	21.84	29.71	39.87
DX-14	7/8	22.22	18.28	1-3/8	34.92	1-1/4	31.75	25.90	21.84	34.54	44.70
DX-16	1	25.40	22.35	1-3/8	34.92	1-1/2	38.10	31.24	26.41	36.83	49.02
DX-20	1-1/4	31.75	27.68	1-11/16	42.86	1-7/8	47.63	41.14	38.86	44.50	66.54
DX-24	1-1/2	38.10	33.90	2	50.80	2-1/4	57.15	50.03	45.21	50.80	77.97
DX-32	2	50.80	45.97	2-3/4	69.85	3	76.20	67.56	62.73	69.80	107.18

Connects metric tube

Part No.	Tube O.D. D	E Min.	Width across flat		A	B	ℓ	L
			h	H				
DX-3M	3	2.4	9.5	12	12.9	15.3	15.7	22.3
DX-4M	4	2.4	12.7	12	13.7	16.1	18.8	25.4
DX-6M	6	4.8	12.7	14	15.3	17.7	19.6	27.0
DX-8M	8	6.4	14.3	16	16.2	18.6	21.3	28.8
DX-10M	10	7.9	17.5	19	17.2	19.5	23.9	31.5
DX-12M	12	9.5	20.6	22	22.8	22.0	25.9	36.0
DX-15M	15	11.9	25.4	25	24.4	22.0	28.7	38.8
DX-16M	16	12.7	25.4	25	24.4	22.0	28.7	38.8
DX-18M	18	15.1	27.0	30	24.4	22.0	29.7	39.8
DX-20M	20	15.9	34.92	32	26.0	22.0	32.5	42.6
DX-22M	22	18.3	34.92	32	26.0	22.0	32.5	42.6
DX-25M	25	21.8	34.92	38	31.3	26.5	36.8	49.1
DX-28M	28	21.8	41.0	46	36.6	36.6	43.2	64.0
DX-32M	32	28.6	46.0	50	42.0	41.6	49.3	72.3
DX-38M	38	33.7	50.8	60	49.4	47.9	56.4	84.0

Bulkhead Union
DUB

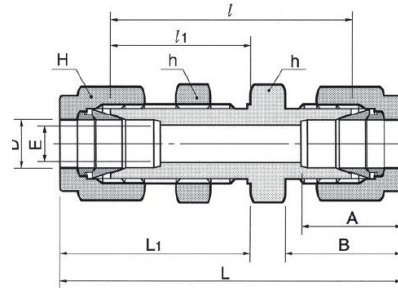

Connects fractional tube

Part No.	Tube O.D. D		E Min.	Width across flat				A	B	ℓ	ℓ1	L	L1	Panel Hole Drill size	Panel Max Thickness
	in.	mm		h		H									
				in.	mm	in.	mm								
DUB-1	1/16	1.59	1.27	5/16	7.93	5/16	7.93	8.63	10.92	23.87	13.46	31.50	17.27	5.16	3.05
DUB-2	1/8	3.17	2.28	1/2	12.70	7/16	11.11	12.70	15.24	38.10	24.63	51.30	31.24	8.33	12.70
DUB-3	3/16	4.76	3.04	9/16	14.28	1/2	12.70	13.71	16.00	40.38	25.40	53.59	32.00	9.92	12.70
DUB-4	1/4	6.35	4.82	5/8	15.87	9/16	14.28	15.24	17.78	42.92	26.16	57.65	33.52	11.50	10.16
DUB-5	5/16	7.93	6.35	11/16	17.46	5/8	15.87	16.25	18.54	45.97	28.44	60.70	35.81	13.09	11.17
DUB-6	3/8	9.52	7.11	3/4	19.05	11/16	17.46	16.76	19.30	47.49	29.46	62.23	36.83	14.68	11.17
DUB-8	1/2	12.70	10.41	15/16	23.81	7/8	22.22	22.86	21.84	50.80	31.75	71.12	41.91	19.44	12.70
DUB-10	5/8	15.87	12.70	1-1/16	26.98	1	25.40	24.38	21.84	52.32	32.51	72.64	42.67	22.62	12.70
DUB-12	3/4	19.05	15.74	1-3/16	30.16	1-1/8	28.58	24.38	21.84	58.67	37.33	78.99	47.49	25.79	16.76
DUB-14	7/8	22.22	18.28	1-3/8	34.92	1-1/4	31.75	25.90	21.84	64.26	42.92	84.58	53.08	28.97	19.05
DUB-16	1	25.40	22.35	1-5/8	41.27	1-1/2	38.10	31.24	26.41	71.37	45.21	95.75	57.40	33.73	19.05
DUB-20	1-1/4	31.75	27.68	1-7/8	47.63	1-7/8	47.63	41.14	38.86	78.99	47.75	123.19	69.85	41.67	19.05
DUB-24	1-1/2	38.10	33.90	2-1/4	57.15	2-1/4	57.15	50.03	45.21	84.83	49.27	139.19	76.45	49.61	19.05
DUB-32	2	50.80	45.97	2-3/4	69.85	3	76.20	67.56	62.73	105.66	56.38	180.34	93.72	57.94	19.05

Connects metric tube

Part No.	Tube O.D. D	E Min.	Width across flat		A	B	ℓ	ℓ1	L	L1	Panel Hole Drill size	Panel Max Thickness
			h	H								
DUB-3M	3	2.4	14	12	12.9	15.3	38.1	24.6	51.3	31.2	8.3	12.7
DUB-4M	4	2.4	14	12	13.7	16.1	40.4	25.4	53.6	32.0	9.9	12.7
DUB-6M	6	4.8	16	14	15.3	17.7	42.9	26.2	57.7	33.6	11.5	10.2
DUB-8M	8	6.4	18	16	16.2	18.6	46.0	28.6	61.0	36.1	13.1	11.2
DUB-10M	10	7.9	22	19	17.2	19.5	48.5	29.4	63.7	37.0	16.2	11.2
DUB-12M	12	9.5	24	22	22.8	22.0	50.8	31.8	71.0	41.9	19.5	12.7
DUB-15M	15	11.9	27	25	24.4	22.0	52.3	32.5	72.5	42.6	22.8	12.7
DUB-16M	16	12.7	27	25	24.4	22.0	52.3	32.5	72.5	42.6	22.8	12.7
DUB-18M	18	15.1	30	30	24.4	22.0	58.7	37.3	78.9	47.4	26.0	16.8
DUB-20M	20	15.9	35	32	26.0	22.0	64.3	42.9	84.5	53.0	29.0	17.0
DUB-22M	22	18.3	35	32	26.0	22.0	64.3	42.9	84.5	53.0	29.0	19.0
DUB-25M	25	21.8	41.3	38	31.3	26.5	71.4	45.2	95.9	57.5	33.7	19.0
DUB-32M	32	28.6	50	50	42.0	41.6	82.3	49.5	128.3	72.5	42.5	19.0
DUB-38M	38	33.7	60	60	49.4	47.9	89.4	51.5	144.6	79.1	50.5	19.0

Bulkhead Retainer

DBR

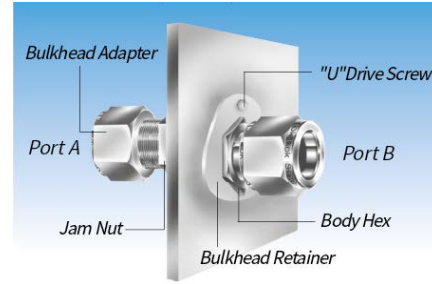
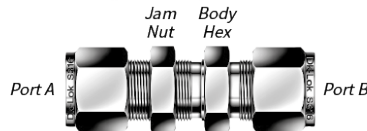
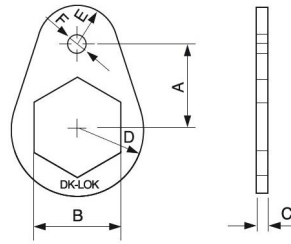

Bulkhead retainer acts as a backup wrench on panel construction. This allows one person to tighten the jam nut on port A side and following tubing connection on port A and B without a backup wrench.

Connects fractional tube

Part No.	DK-Lok O.D.		A	B	C	D	E	F	"U" Drive Screw	Drill Number	Drill Hole Dia
	in.	mm									
DBR-1-S	1/16		9.52	7.94	3.00	7.94	3.97	4.10	#6-3/8	31	3.05
DBR-2-S	1/8		12.70	12.70	3.00	10.31	5.55	4.10	#6-3/8	31	3.05
DBR-3M4M3	3/16	3M,4M	14.28	14.28	3.00	11.90	6.35	4.10	#6-3/8	31	3.05
DBR-6M4	1/4	6M	15.87	15.87	3.00	12.70	7.14	4.10	#6-3/8	31	3.05
DBR-5-S	5/16		17.46	17.46	3.00	14.28	7.94	4.10	#6-3/8	31	3.05
DBR-8M-S		8M	17.46	18.00	3.00	14.28	7.94	4.10	#6-3/8	31	3.05
DBR-6-S	3/8		19.05	19.05	3.00	15.87	8.73	4.10	#6-3/8	31	3.05
DBR-10M-S		10M	23.81	22.00	3.00	19.05	10.31	5.56	#10-1/2	27	3.66
DBR-12M8	1/2	12M	23.81	23.81	3.00	19.05	10.31	5.56	#10-1/2	27	3.66
DBR-15M16M10	5/8	15M,16M	25.40	26.98	3.00	20.64	10.31	5.56	#10-1/2	27	3.66
DBR-18M12	3/4	18M	26.98	30.16	3.00	23.02	11.90	5.56	#10-1/2	27	3.66
DBR-20M22M14	7/8	20M,22M	28.57	34.92	3.00	26.19	13.49	5.56	#10-1/2	27	3.66
DBR-16-S	1		32.54	41.27	3.00	29.37	14.28	5.56	#10-1/2	27	3.66

Bulkhead Elbow Union

DBL

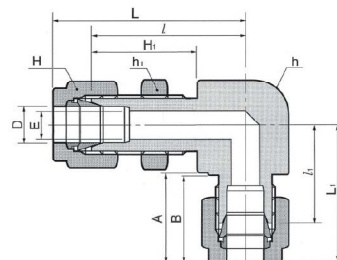

Connects metric tube

Part No.	Tube O.D. mm	E Min.	Width across flat			A	B	ℓ	ℓ1	L	L1	Panel Hole Drill size	Panel Max Thickness
			h	h1	H								
DBL-6M	6	4.8	15.8	14.2	14.0	15.3	17.7	36.5	20.6	43.9	30.0	11.5	10.2
DBL-8M	8	6.4	17.4	17.4	16.0	18.6	46.0	40.9	23.2	48.4	30.7	13.1	11.2
DBL-10M	10	7.9	22.0	22.0	19.0	19.5	48.5	44.5	26.9	52.1	34.5	16.2	11.2
DBL-12M	12	9.5	24.0	23.8	22.0	22.0	50.8	46.9	26.9	57.0	37.0	19.5	12.7
DBL-16M	16	13.5	27.0	27.0	25.0	22.0	52.3	53.5	34.1	63.7	44.5	22.8	12.7
DBL-20M	20	15.9	34.9	35.0	32.0	26.0	22.0	68.4	39.0	78.2	48.7	29.0	17.0
DBL-25M	25	21.8	41.0	41.0	38.0	31.3	26.5	74.2	46.1	86.5	58.4	33.7	19.1

Reducing Union
DUR

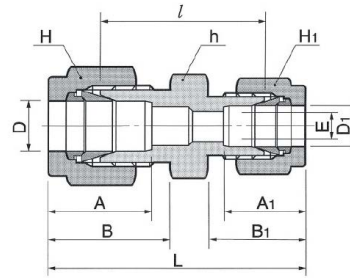

Connects fractional tube

Part No.	Tube O.D.				E Min.	Width across flat						A	A1	B	B1	ℓ	L
	D		D1			h		H		H1							
	in.	mm	in.	mm		in.	mm	in.	mm	in.	mm						
DUR2-1	1/8	3.18	1/16	1.59	1.27	7/16	11.11	7/16	11.11	5/16	7.93	12.70	8.63	15.24	10.92	20.60	30.91
DUR3-1	3/16	4.76	1/16	1.59	1.27	7/16	11.11	1/2	12.70	5/16	7.93	13.71	8.63	16.00	10.92	21.84	32.25
DUR3-2	3/16	4.76	1/8	3.17	2.28	7/16	11.11	1/2	12.70	7/16	11.11	13.71	12.70	16.00	15.24	23.36	36.57
DUR4-1	1/4	6.35	1/16	1.59	1.27	1/2	12.70	9/16	14.28	5/16	7.93	15.24	8.63	17.78	10.92	23.11	34.29
DUR4-2	1/4	6.35	1/8	3.17	2.28	1/2	12.70	9/16	14.28	7/16	11.11	15.24	12.70	17.78	15.24	24.63	38.60
DUR4-3	1/4	6.35	3/16	4.76	3.04	1/2	12.70	9/16	14.28	1/2	12.70	15.24	13.71	17.78	16.00	25.40	39.37
DUR5-2	5/16	7.93	1/8	3.17	2.28	9/16	14.28	5/8	15.87	7/16	11.11	16.25	12.70	18.54	15.24	25.90	39.87
DUR5-4	5/16	7.93	1/4	6.35	4.82	9/16	14.28	5/8	15.87	9/16	14.28	16.25	15.24	18.54	17.78	27.43	42.16
DUR6-1	3/8	9.52	1/16	1.59	1.27	5/8	15.87	11/16	17.46	5/16	7.93	16.76	8.63	19.30	10.92	25.40	36.57
DUR6-2	3/8	9.52	1/8	3.17	2.28	5/8	15.87	11/16	17.46	7/16	11.11	16.76	12.70	19.30	15.24	26.92	40.89
DUR6-4	3/8	9.52	1/4	6.35	4.82	5/8	15.87	11/16	17.46	9/16	14.28	16.76	15.24	19.30	17.78	28.44	43.18
DUR6-5	3/8	9.52	5/16	7.93	6.35	5/8	15.87	11/16	17.46	5/8	15.87	16.76	16.25	19.30	18.54	29.46	44.19
DUR8-2	1/2	12.70	1/8	3.17	2.28	13/16	20.64	7/8	22.22	7/16	11.11	22.86	12.70	21.84	15.24	28.44	45.21
DUR8-4	1/2	12.70	1/4	6.35	4.82	13/16	20.64	7/8	22.22	9/16	14.28	22.86	15.24	21.84	17.78	29.46	46.99
DUR8-6	1/2	12.70	3/8	9.52	7.11	13/16	20.64	7/8	22.22	11/16	17.46	22.86	16.76	21.84	19.30	30.98	48.51
DUR10-6	5/8	15.87	3/8	9.52	7.11	15/16	23.81	1	25.40	11/16	17.46	24.38	16.76	21.84	19.30	31.75	49.27
DUR10-8	5/8	15.87	1/2	12.70	10.41	15/16	23.81	1	25.40	7/8	22.22	24.38	22.86	21.84	21.84	31.75	52.07
DUR12-4	3/4	19.05	1/4	6.35	4.82	1-1/16	26.98	1-1/8	28.57	9/16	14.48	24.38	15.24	21.84	17.78	31.75	49.27
DUR12-6	3/4	19.05	3/8	9.52	7.11	1-1/16	26.98	1-1/8	28.57	11/16	17.46	24.38	16.76	21.84	19.30	33.27	50.80
DUR12-8	3/4	19.05	1/2	12.70	10.41	1-1/16	26.98	1-1/8	28.57	7/8	22.22	24.38	22.86	21.84	21.84	33.27	53.59
DUR12-10	3/4	19.05	5/8	15.87	12.70	1-1/16	26.98	1-1/8	28.57	1	25.40	24.38	24.38	21.84	21.84	33.27	53.59
DUR16-8	1	25.40	1/2	12.70	10.41	1-3/8	34.92	1-1/2	38.10	7/8	22.22	31.24	22.86	26.41	21.84	40.89	63.24
DUR16-12	1	25.40	3/4	19.05	15.74	1-3/8	34.92	1-1/2	38.10	1-1/8	28.58	31.24	24.38	26.41	21.84	40.38	62.73

Connects metric tube

Part No.	Tube O.D.		E Min.	Width across flat			A	A1	B	B1	ℓ	L
	D	D1		h	H	H1						
	DUR3M-2M	3		2	1.7	12						
DUR6M-2M	6	2	1.7	14	14	12	15.3	12.9	17.7	15.3	24.6	38.6
DUR6M-3M	6	3	2.4	14	14	12	15.3	12.9	17.7	15.3	24.6	38.6
DUR6M-4M	6	4	2.4	14	14	12	15.3	13.7	17.7	16.1	25.4	39.4
DUR8M-6M	8	6	4.8	15	16	14	16.2	15.3	18.6	17.7	27.4	42.3
DUR10M-3M	10	3	2.4	18	19	12	17.2	12.9	19.5	15.3	27.7	41.9
DUR10M-4M	10	4	2.4	18	19	12	17.2	13.7	19.5	16.1	28.7	42.9
DUR10M-6M	10	6	4.8	18	19	14	17.2	15.3	19.5	17.7	29.5	44.5
DUR10M-8M	10	8	6.4	18	19	16	17.2	16.2	19.5	18.6	30.0	45.1
DUR12M-6M	12	6	4.8	22	22	14	22.8	15.3	22.0	17.7	29.5	47.0
DUR12M-8M	12	8	6.4	22	22	16	22.8	16.2	22.0	18.6	30.2	47.8
DUR12M-10M	12	10	7.9	22	22	19	22.8	17.2	22.0	19.5	31.0	48.7
DUR15M-12M	15	12	9.8	24	25	22	24.4	17.2	22.0	19.5	31.8	52.5
DUR16M-10M	16	10	7.9	24	25	19	24.4	17.2	22.0	19.5	31.8	49.5
DUR16M-12M	16	12	9.5	24	25	22	24.4	22.8	22.0	22.0	31.8	52.0
DUR18M-10M	18	10	7.9	27	30	19	24.4	17.2	22.0	19.5	33.0	51.0
DUR18M-12M	18	12	9.5	27	30	22	24.4	22.8	22.0	22.0	33.3	53.5
DUR25M-18M	25	18	15.1	35	38	30	31.3	24.4	26.5	22.0	38.6	61.0
DUR25M-20M	25	20	15.9	35	38	32	31.3	26.0	26.5	22.0	39.9	62.3
DUR30M-18M	30	18	15.1	46	50	30	39.7	24.4	39.3	22.0	43.7	75.4
DUR30M-20M	30	20	15.9	46	50	32	39.7	26.0	39.3	22.0	43.7	75.4
DUR30M-25M	30	25	21.8	46	50	38	39.7	31.3	39.3	26.5	46.2	80.1
DUR32M-18M	32	18	15.1	46	50	30	42.0	24.4	41.6	22.0	44.7	77.8
DUR32M-20M	32	20	15.9	46	50	32	42.0	26.0	41.6	22.0	44.7	77.8
DUR32M-25M	32	25	21.8	46	50	38	42.0	31.3	41.6	26.5	47.0	82.3
DUR38M-20M	38	20	15.9	55	60	32	49.4	26.0	47.9	22.0	49.8	87.5
DUR38M-25M	38	25	21.8	55	60	38	49.4	31.3	47.9	26.5	52.1	92.0
DUR38M-30M	30	30	26.2	55	60	50	49.4	39.7	47.9	39.3	55.4	104.6

Reducing Union Elbow

DLR

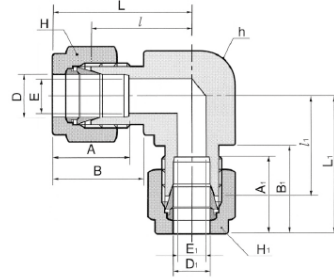

Connects fractional tube

Part No.	Tube O.D.				Width across flat						E	E1	A	A1	B	B1	ℓ	ℓ1	L	L1
	D		D1		h		H		H1											
	in.	mm	in.	mm	in.	mm	in.	mm	in.	mm										
DLR2-1	1/8	3.17	1/16	1.59	3/8	9.52	7/6	11.11	5/16	7.93	2.40	1.30	12.70	8.63	15.24	10.93	15.74	14.20	22.35	18.00
DLR4-2	1/4	6.35	1/8	3.17	1/2	12.70	9/16	14.28	7/6	11.11	4.80	2.40	15.24	12.70	17.78	15.24	19.55	17.90	26.92	24.50
DLR6-4	3/8	9.52	1/4	6.35	5/8	15.87	11/16	17.46	9/16	14.28	7.10	4.80	16.76	15.24	19.30	17.78	23.10	21.92	30.47	29.29
DLR8-4	1/2	12.70	1/4	6.35	13/16	20.64	7/8	22.22	9/16	14.28	10.41	4.80	22.86	15.24	21.84	17.78	25.90	24.40	36.06	31.77
DLR8-6	1/2	12.70	3/8	9.52	13/16	20.64	7/8	22.22	11/16	17.46	10.41	7.10	22.86	16.76	21.84	19.30	25.90	25.90	36.06	33.27

Connects metric tube

Part No.	Tube O.D.			Width across flat						E	E1	A	A1	B	B1	ℓ	ℓ1	L	L1
	D	D1		h		H		H1											
		in.	mm	in.	mm	mm	in.	mm											
DLR8M-4	8.0	1/4	6.35	9/16	14.28	16.0	9/16	14.28	6.4	4.8	16.2	15.24	18.6	17.78	21.3	20.6	28.7	28.0	

Reducing Union Cross

DXR

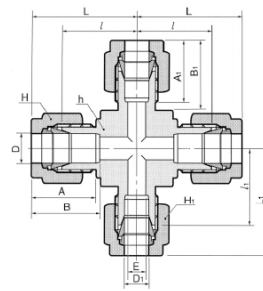
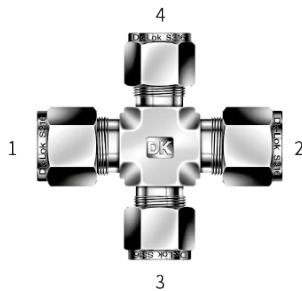

Connects fractional tube

Part No.	Port 1	Port 2	Port 3	Port 4	E Min.	Width across flat						A	A1	B	B1	ℓ	ℓ1	L	L1
	D		D1			h		H		H1									
	in.	mm	in.	mm		in.	mm	in.	mm	in.	mm								
DXR12-12-6-6	3/4	19.05	3/8	9.52	7.10	1-1/16	26.98	1-1/8	28.57	11/16	17.46	24.38	16.76	21.84	19.30	29.71	29.71	39.87	37.07

Connects metric tube

Part No.	Port 1 D	Port 2	Port 3	Port 4	E Min.	Width across flat			A	A1	B	B1	ℓ	ℓ1	L	L1
						D1										
	h	H	H1													
DXR16M-6M-6M-6M	16.0			6.0	4.8	25.4	25.0	14.0	24.4	15.3	22.0	17.7	28.7	27.2	38.8	34.6

Reducing Union Tee

DTR

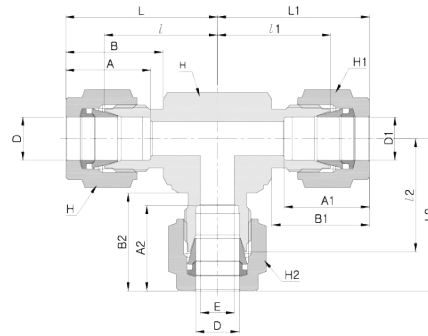

Connects fractional tube

Part No.	Port1 D		Port1 D1		Port1 D2		E Min.	A	A1	A2	B	B1	B2	Width across flat								ℓ	ℓ1	ℓ1	L	L1	L2
	h		H		H1									H2													
	in.	mm	in.	mm	in.	mm								in.	mm	in.	mm	in.	mm								
DTR4-4-2	1/4	6.35	1/4	6.35	1/8	3.17	2.4	15.24	15.24	12.7	17.78	17.78	15.24	1/2	12.7	9/16	14.28	9/16	14.28	7/16	11.11	19.55	19.55	17.9	26.91	26.91	24.5
DTR4-4-6	1/4	6.35	1/4	6.35	3/8	9.52	4.8	15.24	15.24	16.76	17.78	17.78	19.3	5/8	15.87	9/16	14.28	9/16	14.28	11/16	17.46	21.92	21.92	23.1	29.28	29.28	30.46
DTR4-8-8	1/4	6.35	1/2	12.7	1/2	12.7	4.8	15.24	22.86	22.86	17.78	21.84	21.84	13/16	20.64	9/16	14.28	7/8	22.22	7/8	22.22	24.4	25.9	25.9	31.76	36.06	36.06
DTR6-4-6	3/8	9.52	1/4	6.35	3/8	9.52	4.8	16.76	15.24	16.76	19.3	17.78	19.3	5/8	15.87	11/16	17.46	9/16	14.28	11/16	17.46	23.1	21.92	23.1	30.46	29.28	30.46
DTR6-6-4	3/8	9.52	3/8	9.52	1/4	6.35	4.8	16.76	16.76	15.24	19.3	19.3	17.78	5/8	15.87	11/16	17.46	11/16	17.46	9/16	14.28	23.1	23.1	21.92	30.46	30.46	29.28
DTR6-6-8	3/8	9.52	3/8	9.52	1/2	12.7	7.1	16.76	16.76	22.86	19.3	19.3	21.84	13/16	20.64	11/16	17.46	11/16	17.46	7/8	22.22	25.9	25.9	25.9	33.26	33.26	36.06
DTR8-4-6	1/2	12.7	1/4	6.35	3/8	9.52	4.8	22.86	15.24	16.76	21.84	17.78	19.3	13/16	20.64	7/8	22.22	9/16	14.28	11/16	17.46	25.9	25.9	25.9	36.06	33.26	33.26
DTR8-4-8	1/2	12.7	1/4	6.35	1/2	12.7	7.1	22.86	15.24	22.86	21.84	17.78	21.84	13/16	20.64	7/8	22.22	9/16	14.28	7/8	22.22	25.9	24.4	25.9	36.06	31.76	36.06
DTR8-6-6	1/2	12.7	3/8	9.52	3/8	9.52	7.1	22.86	16.76	16.76	21.84	19.3	19.3	13/16	20.64	7/8	22.22	11/16	17.46	11/16	17.46	25.9	25.9	25.9	36.06	33.26	33.26
DTR8-8-4	1/2	12.7	1/2	12.7	1/4	6.35	4.8	22.86	22.86	15.24	21.84	21.84	17.78	13/16	20.64	7/8	22.22	7/8	22.22	9/16	14.28	25.9	25.9	24.4	36.06	36.06	31.76
DTR8-8-6	1/2	12.7	1/2	12.7	3/8	9.52	7.1	22.86	22.86	16.76	21.84	21.84	19.3	13/16	20.64	7/8	22.22	7/8	22.22	11/16	17.46	25.9	25.9	25.9	36.06	36.06	33.26
DTR10-10-6	5/8	15.87	5/8	15.87	3/8	9.52	7.1	24.38	24.38	16.76	21.84	21.84	19.3	15/16	23.81	1	25.4	1	25.4	11/16	17.46	28.7	28.7	28.7	38.86	38.86	36.06
DTR12-8-12	3/4	19.05	1/2	12.7	3/4	19.05	10.41	24.38	22.86	24.38	21.84	21.84	21.84	1-1/16	26.98	1-1/8	28.57	7/8	22.22	1-1/8	28.57	29.71	29.71	29.71	39.87	39.87	39.87
DTR12-12-4	3/4	19.05	3/4	19.05	1/4	6.35	4.8	24.38	24.38	15.24	21.84	21.84	17.78	1-1/16	26.98	1-1/8	28.57	1-1/8	28.57	9/16	14.28	29.71	29.71	28.21	39.87	39.87	35.57
DTR12-12-6	3/4	19.05	3/4	19.05	3/8	9.52	7.1	24.38	24.38	16.76	21.84	21.84	19.3	1-1/16	26.98	1-1/8	28.57	1-1/8	28.57	11/16	17.46	29.71	29.71	29.71	39.87	39.87	35.57
DTR12-12-8	3/4	19.05	3/4	19.05	1/2	12.7	10.41	24.38	24.38	22.86	21.84	21.84	21.84	1-1/16	26.98	1-1/8	28.57	1-1/8	28.57	7/8	22.22	29.71	29.71	29.71	39.87	39.87	38.37
DTR12-12-16	3/4	19.05	3/4	19.05	1	25.4	16.0	24.38	24.38	31.24	21.84	21.84	26.41	1-3/8	34.92	1-1/8	28.57	1-1/8	28.57	1-1/2	38.10	34.43	34.43	36.83	49.02	49.02	45.7
DTR12-12-20	3/4	19.05	3/4	19.05	1-1/4	31.75	16.0	24.38	24.38	41.14	21.84	21.84	38.86	1-11/16	42.86	1-1/8	28.57	1-1/8	28.57	1-7/8	47.63	39.41	39.41	44.45	49.57	49.57	66.55
DTR14-14-8	7/8	22.22	7/8	22.22	1/2	12.7	10.41	25.9	25.9	22.86	21.84	21.84	21.84	1-1/4	31.75	1-1/4	31.75	1-1/4	31.75	7/8	22.22	34.54	34.54	34.54	44.7	44.7	44.7
DTR16-12-12	1	25.4	3/4	19.05	3/4	19.05	16.0	31.24	24.38	24.38	26.41	21.84	21.84	1-3/8	34.92	1-1/2	38.10	1-1/8	28.57	1-1/8	28.57	36.83	35.54	35.54	49.02	45.7	45.7
DTR16-16-4	1	25.4	1	25.4	1/4	6.35	4.8	31.24	31.24	15.24	26.41	26.41	17.78	1-3/8	34.92	1-1/2	38.10	1-1/2	38.10	9/16	14.28	36.83	36.83	33.04	49.02	49.02	40.4
DTR16-16-6	1	25.4	1	25.4	3/8	9.52	7.1	31.24	31.24	16.76	26.41	26.41	19.3	1-3/8	34.92	1-1/2	38.10	1-1/2	38.10	11/16	17.46	36.83	36.83	34.54	49.02	49.02	41.9
DTR16-16-8	1	25.4	1	25.4	1/2	12.7	10.41	31.24	31.24	22.86	26.41	26.41	21.84	1-3/8	34.92	1-1/2	38.10	1-1/2	38.10	7/8	22.22	36.83	36.83	34.54	49.02	49.02	44.7
DTR16-16-12	1	25.4	1	25.4	3/4	19.05	16.0	31.24	31.24	24.38	26.41	26.41	21.84	1-3/8	34.92	1-1/2	38.10	1-1/2	38.10	1-1/8	28.57	36.83	36.83	35.54	49.02	49.02	45.7
DTR20-12-12	1 1/4	31.75	3/4	19.05	3/4	19.05	16.0	41.14	24.38	24.38	38.86	21.84	21.84	1-11/16	42.86	1-7/8	47.63	1-1/8	28.57	1-1/8	28.57	44.45	39.41	39.41	66.55	49.57	49.57
DTR20-20-12	1 1/4	31.75	1 1/4	31.75	3/4	19.05	16.0	41.14	41.14	24.38	38.86	38.86	21.84	1-11/16	42.86	1-7/8	47.63	1-7/8	47.63	1-1/8	28.57	44.45	44.45	39.41	66.55	66.55	49.57
DTR24-20-20	1 1/2	38.10	1 1/4	31.75	1 1/4	31.75	27.69	50.03	41.14	41.14	45.21	38.86	38.86	2	50.8	2-1/4	57.15	1-7/8	47.63	1-7/8	47.63	50.8	49.62	49.62	77.97	71.72	71.72
DTR24-24-8	1 1/2	38.10	1 1/2	38.10	1/2	12.7	10.41	50.03	50.03	22.86	45.21	45.21	21.84	2	50.8	2-1/4	57.15	2-1/4	57.15	7/8	22.22	50.8	50.8	44.58	77.97	77.97	54.74
DTR24-24-12	1 1/2	38.10	1 1/2	38.10	3/4	19.05	16.0	50.03	50.03	24.38	45.21	45.21	21.84	2	50.8	2-1/4	57.15	2-1/4	57.15	1-1/8	28.57	50.8	50.8	44.58	77.97	77.97	54.74
DTR24-24-16	1 1/2	38.10	1 1/2	38.10	1	25.4	22.3	50.03	50.03	31.24	45.21	45.21	26.41	2	50.8	2-1/4	57.15	2-1/4	57.15	1-1/2	38.10	50.8	50.8	47.75	77.97	77.97	59.94

Reducing Union Tee DTR

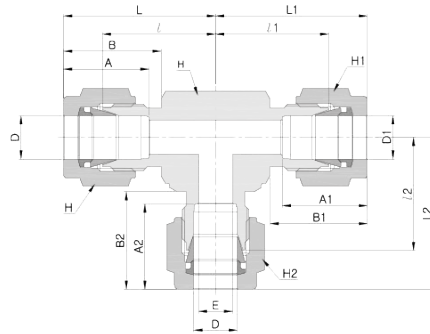

Connects metric tube

Part No.	Port 1 D	Port 2 D1	Port 3 D2	E Min.	Width across flat				A	A1	A2	B	B1	B2	ℓ	ℓ1	ℓ1	L	L1	L2
					h	H	H1	H2												
DTR3M-3M-6M	3	3	6	2.4	12.7	12	12	14	12.9	12.9	15.3	15.3	15.3	17.7	18.0	18.0	19.6	24.6	24.6	27.0
DTR8M-8M-6M	8	8	6	4.8	15	16	16	14	16.2	16.2	15.3	18.6	18.6	17.7	21.3	21.3	20.5	28.8	28.8	28.0
DTR10M-10M-6M	10	10	6	4.8	17.4	19	19	14	17.2	17.2	15.3	19.5	19.5	17.7	23.9	23.9	22.4	31.5	31.5	29.8
DTR10M-10M-12M	10	10	12	7.9	20.6	19	19	22	17.2	17.2	22.8	19.5	19.5	22.0	25.9	25.9	25.9	33.5	33.5	36.0
DTR12M-6M-10M	12	6	10	4.8	20.6	22	14	19	22.8	15.3	17.2	22.0	17.7	19.5	25.9	24.4	25.9	36.0	31.8	33.5
DTR12M-6M-12M	12	6	12	4.8	20.6	22	14	22	22.8	15.3	22.8	22.0	17.7	22.0	25.9	24.4	25.9	36.0	31.8	36.0
DTR12M-10M-10M	12	10	10	7.9	20.6	22	19	19	22.8	17.2	17.2	22.0	19.5	19.5	25.9	25.9	25.9	36.0	33.5	33.5
DTR12M-12M-10M	12	12	10	7.9	20.6	22	22	19	22.8	22.8	17.2	22.0	22.0	19.5	25.9	25.9	25.9	36.0	36.0	33.5
DTR12M-12M-6M	12	12	6	4.8	20.6	22	22	14	22.8	22.8	15.3	22.0	22.0	17.7	25.9	25.9	24.4	36.0	36.0	31.8
DTR15M-15M-12M	15	15	12	9.8	25.4	25	25	22	24.4	24.4	22.8	22.0	22.0	22.0	28.7	28.7	28.7	38.8	38.8	38.8
DTR16M-16M-12M	16	16	12	9.8	25.4	25	25	22	24.4	24.4	22.8	22.0	22.0	22.0	28.7	28.7	28.7	38.8	38.8	38.8
DTR18M-18M-12M	18	18	12	9.8	27	30	30	22	24.4	24.4	22.8	22.0	22.0	22.0	29.7	29.7	28.2	39.8	39.8	38.3
DTR20M-12M-20M	20	12	20	9.8	34.9	32	22	32	26.0	22.8	26.0	22.0	22.0	22.0	32.5	32.5	32.5	42.6	42.6	42.6
DTR20M-20M-6M	20	20	6	4.8	34.9	32	32	14	26.0	26.0	15.3	22.0	22.0	17.7	32.5	32.5	31.0	42.6	42.6	38.4
DTR20M-20M-10M	20	20	10	7.9	34.9	32	32	19	26.0	26.0	17.2	22.0	22.0	19.5	32.5	32.5	32.5	42.6	42.6	40.1
DTR20M-20M-12M	20	20	12	9.8	34.9	32	32	22	26.0	26.0	22.8	22.0	22.0	22.0	32.5	32.5	32.5	42.6	42.6	42.6
DTR20M-20M-25M	20	20	25	15.9	34.9	32	32	38	26.0	26.0	31.3	22.0	22.0	26.5	34.3	34.3	36.8	44.4	44.4	49.1
DTR20M-20M-32M	20	20	32	15.9	46	32	32	50	26.0	26.0	42.0	22.0	22.0	41.6	42.5	42.5	49.3	52.6	52.6	72.3
DTR22M-22M-12M	22	22	12	9.8	34.9	32	32	22	26.0	26.0	22.8	22.0	22.0	22.0	32.5	32.5	32.5	42.6	42.6	42.6
DTR25M-20M-20M	25	20	20	15.9	34.9	38	32	32	31.3	26.0	26.0	26.5	22.0	22.0	36.8	34.3	34.3	49.1	44.4	44.4
DTR25M-25M-10M	25	25	10	7.9	34.9	38	38	19	31.3	31.3	17.2	26.5	26.5	19.5	36.8	36.8	34.3	49.1	49.1	38.9
DTR25M-25M-12M	25	25	12	9.8	34.9	38	38	22	31.3	31.3	22.8	26.5	26.5	22.0	36.8	36.8	34.3	49.1	49.1	44.4
DTR25M-25M-20M	25	25	20	15.9	34.9	38	38	32	31.3	31.3	26.0	26.5	26.5	22.0	36.8	36.8	34.3	49.1	49.1	44.4
DTR32M-32M-20M	32	32	20	15.9	46	38	38	32	42.0	42.0	26.0	41.6	41.6	22.0	49.3	49.3	42.5	72.3	72.3	52.6
DTR38M-32M-32M	38	32	32	28.6	50.8	60	38	38	49.4	42.0	42.0	47.9	41.6	41.6	56.4	54.7	54.7	84.0	77.7	77.7
DTR38M-38M-20M	38	38	20	15.9	50.8	60	60	32	49.4	49.4	26.0	47.9	47.9	22.0	56.4	56.4	47.9	84.0	84.0	58.0
DTR38M-38M-25M	38	38	25	21.8	50.8	60	60	38	49.4	49.4	31.3	47.9	47.9	26.5	56.4	56.4	50.4	84.0	84.0	62.7

Male Connector
DMC-N

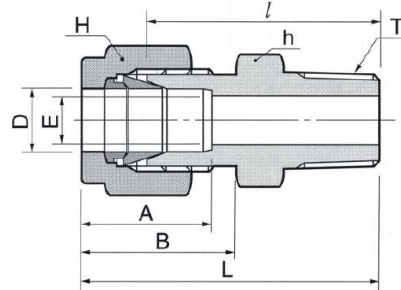

Connects fractional tube to female NPT thread

Part No.	Tube O.D. D		T NPT	E Min.	Width across flat				A	B	ℓ	L
	in.	mm			h		H					
					in.	mm	in.	mm				
DMC1-1N	1/16	1.59	1/16	1.27	5/16	7.93	5/16	7.93	8.63	10.92	20.00	23.83
DMC1-2N	1/16	1.59	1/8	1.27	7/16	11.11	5/16	7.93	8.63	10.92	22.35	26.23
DMC1-4N	1/16	1.59	1/4	1.27	9/16	14.28	5/16	7.93	8.63	10.92	27.17	30.98
DMC2-1N	1/8	3.17	1/16	2.28	7/16	11.11	7/16	11.11	12.70	15.24	23.11	29.71
DMC2-2N	1/8	3.17	1/8	2.28	7/16	11.11	7/16	11.11	12.70	15.24	23.87	30.48
DMC2-4N	1/8	3.17	1/4	2.28	9/16	14.28	7/16	11.11	12.70	15.24	28.95	35.56
DMC2-6N	1/8	3.17	3/8	2.28	11/16	17.46	7/16	11.11	12.70	15.24	29.21	35.81
DMC2-8N	1/8	3.17	1/2	2.28	7/8	22.22	7/16	11.11	12.70	15.24	35.56	42.16
DMC3-2N	3/16	4.76	1/8	3.04	7/16	11.11	1/2	12.70	13.71	16.00	24.63	31.24
DMC3-4N	3/16	4.76	1/4	3.04	9/16	14.28	1/2	12.70	13.71	16.00	29.71	36.32
DMC4-1N	1/4	6.35	1/16	4.82	1/2	12.70	9/16	14.28	15.24	17.78	25.40	32.76
DMC4-2N	1/4	6.35	1/8	4.82	1/2	12.70	9/16	14.28	15.24	17.78	25.40	32.76
DMC4-4N	1/4	6.35	1/4	4.82	9/16	14.28	9/16	14.28	15.24	17.78	30.48	37.84
DMC4-6N	1/4	6.35	3/8	4.82	11/16	17.46	9/16	14.28	15.24	17.78	30.98	38.35
DMC4-8N	1/4	6.35	1/2	4.82	7/8	22.22	9/16	14.28	15.24	17.78	37.33	44.70
DMC4-12N	1/4	6.35	3/4	4.82	1-1/16	26.98	9/16	14.28	15.24	17.78	38.86	46.22
DMC5-2N	5/16	7.93	1/8	4.82	9/16	14.28	5/8	15.87	16.25	18.54	26.67	34.03
DMC5-4N	5/16	7.93	1/4	6.35	9/16	14.28	5/8	15.87	16.25	18.54	31.24	38.60
DMC5-6N	5/16	7.93	3/8	6.35	11/16	17.46	5/8	15.87	16.25	18.54	31.75	39.11
DMC5-8N	5/16	7.93	1/2	6.35	7/8	22.22	5/8	15.87	16.25	18.54	38.11	45.60
DMC6-2N	3/8	9.52	1/8	4.82	5/8	15.87	11/16	17.46	16.76	19.30	27.94	35.30
DMC6-4N	3/8	9.52	1/4	7.11	5/8	15.87	11/16	17.46	16.76	19.30	32.51	39.87
DMC6-6N	3/8	9.52	3/8	7.11	11/16	17.46	11/16	17.46	16.76	19.30	32.51	39.87
DMC6-8N	3/8	9.52	1/2	7.11	7/8	22.22	11/16	17.46	16.76	19.30	38.86	46.22
DMC6-12N	3/8	9.52	3/4	7.11	1-1/16	26.98	11/16	17.46	16.76	19.30	40.38	47.75
DMC6-16N	3/8	9.52	1	7.11	1-3/8	34.92	11/16	17.46	16.76	19.30	47.0	54.37
DMC8-2N	1/2	12.70	1/8	4.82	13/16	20.64	7/8	22.22	22.86	21.84	28.70	38.86
DMC8-4N	1/2	12.70	1/4	7.11	13/16	20.64	7/8	22.22	22.86	21.84	33.27	43.43
DMC8-6N	1/2	12.70	3/8	9.65	13/16	20.64	7/8	22.22	22.86	21.84	33.27	43.43
DMC8-8N	1/2	12.70	1/2	10.41	7/8	22.22	7/8	22.22	22.86	21.84	38.86	49.02
DMC8-12N	1/2	12.70	3/4	10.41	1-1/16	26.98	7/8	22.22	22.86	21.84	40.38	50.54
DMC8-16N	1/2	12.70	1	10.41	1-3/8	34.92	7/8	22.22	22.86	21.84	46.99	57.15
DMC10-4N	5/8	15.87	1/4	6.35	15/16	23.81	1	25.40	24.38	21.84	33.80	43.96
DMC10-6N	5/8	15.87	3/8	9.65	15/16	23.81	1	25.40	24.38	21.84	34.03	44.19
DMC10-8N	5/8	15.87	1/2	11.93	15/16	23.81	1	25.40	24.38	21.84	38.86	49.02
DMC10-12N	5/8	15.87	3/4	12.70	1-1/16	26.98	1	25.40	24.38	21.84	40.38	50.54
DMC12-6N	3/4	19.05	3/8	9.65	1-1/16	26.98	1-1/8	28.58	24.38	21.84	34.03	44.19
DMC12-8N	3/4	19.05	1/2	11.93	1-1/16	26.98	1-1/8	28.58	24.38	21.84	40.38	50.54
DMC12-12N	3/4	19.05	3/4	15.74	1-1/16	26.98	1-1/8	28.58	24.38	21.84	40.38	50.54
DMC12-16N	3/4	19.05	1	15.74	1-3/8	34.92	1-1/8	28.58	24.38	21.84	46.99	57.15
DMC14-8N	7/8	22.22	1/2	11.9	1-3/16	30.16	1-1/4	31.75	25.90	21.84	40.38	50.54
DMC14-12N	7/8	22.22	3/4	15.74	1-3/16	30.16	1-1/4	31.75	25.90	21.84	40.38	50.54
DMC14-16N	7/8	22.22	1	18.28	1-3/8	34.92	1-1/4	31.75	25.90	21.84	46.99	57.15
DMC16-6N	1	25.40	3/8	9.65	1-3/8	34.92	1-1/2	38.10	31.24	26.41	40.30	52.49
DMC16-8N	1	25.40	1/2	11.93	1-3/8	34.92	1-1/2	38.10	31.24	26.41	45.21	57.40
DMC16-12N	1	25.40	3/4	15.74	1-3/8	34.92	1-1/2	38.10	31.24	26.41	45.21	57.40
DMC16-16N	1	25.40	1	22.35	1-3/8	34.62	1-1/2	38.10	31.24	26.41	50.03	62.23

Connects fractional tube to female NPT thread

Part No.	Tube O.D. D		T NPT	E Min.	Width across flat				A	B	ℓ	L
	in.	mm			h		H					
					in.	mm	in.	mm				
DMC20-16N	1-1/4	31.75	1	22.35	1-3/4	44.45	1-7/8	47.63	41.14	38.86	55.11	77.21
DMC20-20N	1-1/4	31.75	1-1/4	27.68	1-3/4	44.45	1-7/8	47.63	41.14	38.86	55.11	77.21
DMC20-24N	1-1/4	31.75	1-1/2	27.68	1-3/4	44.45	1-7/8	47.63	41.14	38.86	60.54	82.64
DMC24-16N	1-1/2	38.10	1	22.30	2-1/8	53.98	2-1/4	57.15	50.03	45.21	59.42	86.60
DMC24-20N	1-1/2	38.10	1-1/4	27.68	2-1/8	53.98	2-1/4	57.15	50.03	45.21	59.42	86.60
DMC24-24N	1-1/2	38.10	1-1/2	33.90	2-1/8	53.98	2-1/4	57.15	50.03	45.21	61.72	88.90
DMC24-32N	1-1/2	38.10	2	33.90	2-3/4	69.85	2-1/4	57.15	50.03	45.21	62.42	99.75
DMC32-8N	2	50.80	1/2	11.93	2-3/4	69.85	3	76.20	67.56	62.73	68.40	105.73
DMC32-20N	2	50.80	1-1/4	45.97	2-3/4	69.85	3	76.20	67.56	62.73	71.40	108.73
DMC32-24N	2	50.80	1-1/2	45.97	2-3/4	69.85	3	76.20	67.56	62.73	75.50	112.83
DMC32-32N	2	50.80	2	45.97	2-3/4	69.85	3	76.20	67.56	62.73	76.20	113.53

Connects metric tube to female NPT thread

Part No.	Tube O.D. D	T NPT	E Min.	Width across flat		A	B	ℓ	L
				h	H				
DMC2M-2N	2	1/8	1.7	12	12	12.9	15.3	23.9	30.5
DMC3M-2N	3	1/8	2.4	12	12	12.9	15.3	23.1	29.7
DMC3M-4N	3	1/4	2.4	14	12	12.9	15.3	29.0	35.6
DMC4M-2N	4	1/8	2.4	12	12	13.7	16.1	24.6	31.2
DMC4M-4N	4	1/4	2.4	14	12	13.7	16.1	29.7	36.3
DMC6M-2N	6	1/8	4.8	14	14	15.3	17.7	25.4	32.8
DMC6M-4N	6	1/4	4.8	14	14	15.3	17.7	30.2	37.6
DMC6M-6N	6	3/8	4.8	18	14	15.3	17.7	31.0	38.4
DMC6M-8N	6	1/2	4.8	22	14	15.3	17.7	37.3	44.0
DMC8M-2N	8	1/8	4.8	15	16	16.2	18.6	26.7	34.2
DMC8M-4N	8	1/4	6.4	15	16	16.2	18.6	31.2	38.7
DMC8M-6N	8	3/8	6.4	18	16	16.2	18.6	31.8	39.2
DMC8M-8N	8	1/2	6.4	22	16	16.2	18.6	37.3	44.8
DMC10M-2N	10	1/8	4.8	18	19	17.2	19.5	28.7	36.3
DMC10M-4N	10	1/4	7.1	18	19	17.2	19.5	33.3	40.9
DMC10M-6N	10	3/8	7.9	18	19	17.2	19.5	33.3	40.9
DMC10M-8N	10	1/2	7.9	22	19	17.2	19.5	38.1	45.7
DMC10M-12N	10	3/4	7.9	27	19	17.2	19.5	38.9	46.5
DMC12M-2N	12	1/8	4.8	22	22	22.8	22.0	28.7	38.8
DMC12M-4N	12	1/4	7.1	22	22	22.8	22.0	33.3	43.4
DMC12M-6N	12	3/8	9.5	22	22	22.8	22.0	33.3	43.4
DMC12M-8N	12	1/2	9.5	22	22	22.8	22.0	38.1	48.2
DMC12M-12N	12	3/4	9.5	27	22	22.8	22.0	38.9	49.0
DMC14M-4N	14	1/4	6.4	24	25	24.4	22.0	34.0	44.1
DMC14M-6N	14	3/8	9.5	24	25	24.4	22.0	34.0	44.1
DMC14M-8N	14	1/2	11.1	24	25	24.4	22.0	34.0	44.1
DMC15M-8N	15	1/2	11.9	24	25	24.4	22.0	38.9	49.0
DMC16M-4N	16	1/4	7.1	24	25	24.4	22.0	34.0	44.1
DMC16M-6N	16	3/8	9.5	24	25	24.4	22.0	34.0	44.1
DMC16M-8N	16	1/2	11.9	24	25	24.4	22.0	38.9	49.0
DMC16M-12N	16	3/4	12.7	27	25	24.4	22.0	38.9	49.0
DMC18M-8N	18	1/2	11.9	27	30	24.4	22.0	40.4	50.5
DMC18M-12N	18	3/4	15.1	27	30	24.4	22.0	40.4	50.5
DMC20M-8N	20	1/2	11.9	30	32	26.0	22.0	42.2	52.3
DMC20M-12N	20	3/4	15.9	30	32	26.0	22.0	42.2	52.3
DMC22M-12N	22	3/4	15.9	30	32	26.0	22.0	42.2	52.3
DMC22M-16N	22	1	18.3	35	32	26.0	22.0	47.8	57.9
DMC25M-8N	25	1/2	11.9	35	38	31.3	26.5	45.2	57.5
DMC25M-12N	25	3/4	15.9	35	38	31.3	26.5	45.2	57.5
DMC25M-16N	25	1	21.8	35	38	31.3	26.5	50.0	62.3
DMC28M-16N	28	1	21.8	41	46	36.6	36.6	51.6	72.4
DMC28M-20N	28	1-1/4	21.8	46	46	36.6	36.6	52.3	73.1
DMC30M-20N	30	1-1/4	26.2	46	50	39.6	39.2	55.6	77.2
DMC32M-20N	32	1-1/4	28.6	46	50	42.0	41.6	56.6	79.6
DMC38M-24N	38	1-1/2	33.7	55	60	49.4	47.9	64.0	91.6

Male Connector
DMC-R

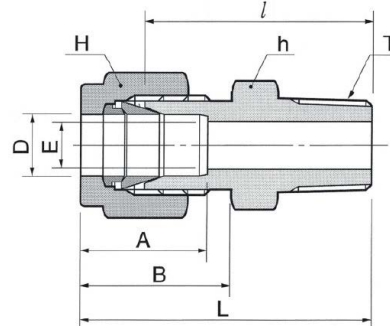

Connects fractional tube to female ISO tapered thread

Part No.	Tube O.D. D		T NPT	E Min.	Width across flat				A	B	ℓ	L
	in.	mm			h		H					
					in.	mm	in.	mm				
DMC2-2R	1/8	3.17	1/8	2.28	7/16	11.11	7/16	11.11	12.70	15.24	23.87	30.48
DMC2-4R	1/8	3.17	1/4	2.28	9/16	14.28	7/16	11.11	12.70	15.24	28.95	35.56
DMC4-2R	1/4	6.35	1/8	4.82	1/2	12.70	9/16	14.28	15.24	17.78	25.40	32.76
DMC4-4R	1/4	6.35	1/4	4.82	9/16	14.28	9/16	14.28	15.24	17.78	30.48	37.84
DMC4-6R	1/4	6.35	3/8	4.82	11/16	17.46	9/16	14.28	15.24	17.78	30.98	38.35
DMC4-8R	1/4	6.35	1/2	4.82	7/8	22.22	9/16	14.28	15.24	17.78	37.33	44.70
DMC5-2R	5/16	7.93	1/8	4.82	9/16	14.28	5/8	15.87	16.25	18.54	26.67	34.03
DMC5-4R	5/16	7.93	1/4	6.35	9/16	14.28	5/8	15.87	16.25	18.54	31.24	38.60
DMC5-16R	5/16	7.93	1	6.35	1-3/8	34.92	5/8	15.87	16.25	18.54	46.2	50.0
DMC6-2R	3/8	9.52	1/8	4.82	5/8	15.87	11/16	17.46	16.76	19.30	27.94	35.30
DMC6-4R	3/8	9.52	1/4	7.11	5/8	15.87	11/16	17.46	16.76	19.30	32.51	39.87
DMC6-6R	3/8	9.52	3/8	7.11	11/16	17.46	11/16	17.46	16.76	19.30	32.51	39.87
DMC6-8R	3/8	9.52	1/2	7.11	7/8	22.22	11/16	17.46	16.76	19.30	38.86	46.22
DMC6-12R	3/8	9.52	3/4	7.11	1-1/16	26.98	11/16	17.46	16.76	19.30	40.38	47.75
DMC8-2R	1/2	12.70	1/8	4.82	13/16	20.64	7/8	22.22	22.86	21.84	28.70	38.86
DMC8-4R	1/2	12.70	1/4	7.11	13/16	20.64	7/8	22.22	22.86	21.84	33.27	43.43
DMC8-6R	1/2	12.70	3/8	9.65	13/16	20.64	7/8	22.22	22.86	21.84	33.27	43.43
DMC8-8R	1/2	12.70	1/2	10.41	7/8	22.22	7/8	22.22	22.86	21.84	38.86	49.02
DMC8-12R	1/2	12.70	3/4	10.41	1-1/16	26.98	7/8	22.22	22.86	21.84	40.38	50.54
DMC8-16R	1/2	12.70	1	10.41	1-3/8	34.92	7/8	22.22	22.86	21.84	46.99	57.15
DMC10-6R	5/8	15.87	3/8	9.65	15/16	23.81	1	25.40	24.38	21.84	34.03	44.19
DMC10-8R	5/8	15.87	1/2	11.93	15/16	23.81	1	25.40	24.38	21.84	38.86	49.02
DMC10-12R	5/8	15.87	3/4	12.70	1-1/16	26.98	1	25.40	24.38	21.84	40.38	50.54
DMC12-8R	3/4	19.05	1/2	11.93	1-1/16	26.98	1-1/8	28.58	24.38	21.84	40.38	50.54
DMC12-12R	3/4	19.05	3/4	15.74	1-1/16	26.98	1-1/8	28.58	24.38	21.84	40.38	50.54
DMC12-16R	3/4	19.05	1	15.74	1-3/8	34.92	1-1/8	28.58	24.38	21.84	46.99	57.15
DMC16-12R	1	25.40	3/4	15.74	1-3/8	34.92	1-1/2	38.10	31.24	26.41	45.21	57.40
DMC16-16R	1	25.40	1	22.35	1-3/8	34.62	1-1/2	38.10	31.24	26.41	50.03	62.23
DMC20-12R	1-1/4	31.75	3/4	15.74	1-3/4	44.45	1-7/8	47.63	41.14	38.86	50.0	72.10
DMC20-16R	1-1/4	31.75	1	22.35	1-3/4	44.45	1-7/8	47.63	41.14	38.86	55.11	77.21
DMC20-20R	1-1/4	31.75	1-1/4	27.68	1-3/4	44.45	1-7/8	47.63	41.14	38.86	55.11	77.21
DMC32-32R	2	50.80	2	45.97	2-3/4	69.85	3	76.20	67.56	62.73	76.20	113.53

Thermocouple Connector
DMCT



Most DK-Lok male connectors can be bored-through thermocouple fittings except those fittings with small male thread like 1/8 in.

To order, insert T in DMC male connector part number. Example: DMCT8-8N-S

DK-Lok bored-through fittings have no shoulder or sizing angle inside the body. This allows thermocouples or dip tubes to pass beyond the fitting male thread.

Assembly instruction

1. Position the length of thermocouple to pass through fitting male thread and hold it to prevent shifting during assembly.
2. Wrench tightens the nut 1 1/4 turns from finger tight position, keeping the body steady with backup wrench.
 - Tighten the nut 3/4 turn for 1/8, and 3/16; 3, and 4mm Tube Fittings.

Male Connector DMC-R

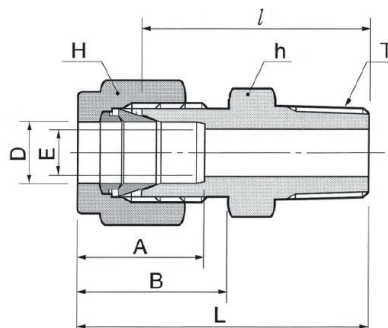

Connects metric tube to female ISO tapered thread

Part No.	Tube O.D. D	T NPT	E Min.	Width across flat		A	B	ℓ	L
				h	H				
DMC2M-2R	2	1/8	1.7	12	12	12.9	15.3	23.9	30.5
DMC3M-2R	3	1/8	2.4	12	12	12.9	15.3	23.1	29.7
DMC3M-4R	3	1/4	2.4	14	12	12.9	15.3	29.0	35.6
DMC4M-2R	4	1/8	2.4	12	12	13.7	16.1	24.6	31.2
DMC4M-4R	4	1/4	2.4	14	12	13.7	16.1	29.7	36.3
DMC6M-2R	6	1/8	4.8	14	14	15.3	17.7	25.4	32.8
DMC6M-4R	6	1/4	4.8	14	14	15.3	17.7	30.2	37.6
DMC6M-6R	6	3/8	4.8	18	14	15.3	17.7	31.0	38.4
DMC6M-8R	6	1/2	4.8	22	14	15.3	17.7	37.3	44.0
DMC8M-2R	8	1/8	4.8	15	16	16.2	18.6	26.7	34.2
DMC8M-4R	8	1/4	6.4	15	16	16.2	18.6	31.2	38.7
DMC8M-6R	8	3/8	6.4	18	16	16.2	18.6	31.8	39.2
DMC8M-8R	8	1/2	6.4	22	16	16.2	18.6	37.3	44.8
DMC10M-2R	10	1/8	4.8	18	19	17.2	19.5	28.7	36.3
DMC10M-4R	10	1/4	7.1	18	19	17.2	19.5	33.3	40.9
DMC10M-6R	10	3/8	7.9	18	19	17.2	19.5	33.3	40.9
DMC10M-8R	10	1/2	7.9	22	19	17.2	19.5	38.1	45.7
DMC10M-12R	10	3/4	7.9	27	19	17.2	19.5	38.9	46.5
DMC12M-4R	12	1/4	7.1	22	22	22.8	22.0	33.3	43.4
DMC12M-6R	12	3/8	9.5	22	22	22.8	22.0	33.3	43.4
DMC12M-8R	12	1/2	9.5	22	22	22.8	22.0	38.1	48.2
DMC12M-12R	12	3/4	9.5	27	22	22.8	22.0	38.9	49.0
DMC14M-6R	14	3/8	9.5	24	25	24.4	22.0	34.0	44.1
DMC14M-8R	14	1/2	11.1	24	25	24.4	22.0	34.0	44.1
DMC15M-6R	15	3/8	9.5	24	25	24.4	22.0	34.0	44.1
DMC15M-8R	15	1/2	11.9	24	25	24.4	22.0	38.9	49.0
DMC16M-4R	16	1/4	7.1	24	25	24.4	22.0	34.0	44.1
DMC16M-6R	16	3/8	9.5	24	25	24.4	22.0	34.0	44.1
DMC16M-8R	16	1/2	11.9	24	25	24.4	22.0	38.9	49.0
DMC16M-12R	16	3/4	12.7	27	25	24.4	22.0	38.9	49.0
DMC18M-8R	18	1/2	11.9	27	30	24.4	22.0	40.4	50.5
DMC18M-12R	18	3/4	15.1	27	30	24.4	22.0	40.4	50.5
DMC20M-8R	20	1/2	11.9	30	32	26.0	22.0	42.2	52.3
DMC20M-12R	20	3/4	15.9	30	32	26.0	22.0	42.2	52.3
DMC22M-8R	22	1/2	11.9	30	32	26.0	22.0	42.2	52.3
DMC22M-12R	22	3/4	15.9	30	32	26.0	22.0	42.2	52.3
DMC22M-16R	22	1	18.3	35	32	26.0	22.0	47.8	57.9
DMC25M-8R	25	1/2	11.9	35	38	31.3	26.5	45.2	57.5
DMC25M-12R	25	3/4	15.9	35	38	31.3	26.5	45.2	57.5
DMC25M-16R	25	1	21.8	35	38	31.3	26.5	50.0	62.3
DMC28M-16R	28	1	21.8	41	46	36.6	36.6	51.6	72.4
DMC28M-20R	28	1-1/4	21.8	46	46	36.6	36.6	52.3	73.1
DMC30M-20R	30	1-1/4	26.2	46	50	39.6	39.2	55.6	77.2
DMC32M-20R	32	1-1/4	28.6	46	50	42.0	41.6	56.6	79.6
DMC38M-24R	38	1-1/2	33.7	55	60	49.4	47.9	64.0	91.6

Male Connector
DMC-G

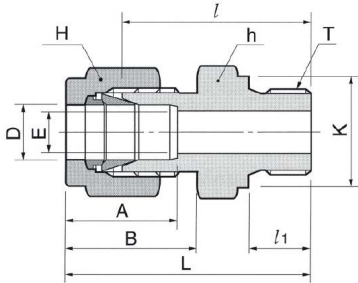

Connects fractional tube to female ISO tapered thread

Part No.	Tube O.D. D		T PF	E Min.	Width across flat				A	B	ℓ	ℓ1	L	K
	in.	mm			h		H							
					in.	mm	in.	mm						
DMC2-2G	1/8	3.17	1/8	2.28	9/16	14.28	7/16	11.11	12.70	15.24	23.37	7.11	29.97	13.80
DMC2-4G	1/8	3.17	1/4	2.28	3/4	19.05	7/16	11.11	12.70	15.24	28.70	11.18	35.31	18.00
DMC2-6G	1/8	3.17	3/8	2.28	7/8	22.22	7/16	11.11	12.70	15.24	29.72	11.18	36.21	21.80
DMC4-2G	1/4	6.35	1/8	2.28	9/16	14.28	9/16	14.28	15.24	17.78	24.89	7.11	32.26	13.80
DMC4-4G	1/4	6.35	1/4	4.8	3/4	19.05	9/16	14.28	15.24	17.78	30.23	11.18	37.59	18.00
DMC4-6G	1/4	6.35	3/8	4.8	7/8	22.22	9/16	14.28	15.24	17.78	31.50	11.18	38.86	21.80
DMC4-8G	1/4	6.35	1/2	4.8	1-1/16	26.98	9/16	14.28	15.24	17.78	37.34	14.22	44.70	26.00
DMC6-2G	3/8	9.52	1/8	4.8	5/8	15.87	11/16	17.46	16.76	19.30	26.40	7.11	33.77	13.80
DMC6-4G	3/8	9.52	1/4	4.82	3/4	19.05	11/16	17.46	16.76	19.30	31.75	11.18	39.12	18.00
DMC6-6G	3/8	9.52	3/8	7.11	7/8	22.22	11/16	17.46	16.76	19.30	33.02	11.18	40.39	21.80
DMC6-8G	3/8	9.52	1/2	7.11	1-1/16	26.98	11/16	17.46	16.76	19.30	38.86	14.22	46.23	26.00
DMC8-4G	1/2	12.70	1/4	7.11	13/16	20.64	7/8	22.22	22.86	21.84	32.51	11.18	42.67	18.00
DMC8-6G	1/2	12.70	3/8	7.90	7/8	22.22	7/8	22.22	22.86	21.84	33.02	11.18	43.18	21.80
DMC8-8G	1/2	12.70	1/2	10.41	1-1/16	26.98	7/8	22.22	22.86	21.84	38.86	14.22	49.02	26.00
DMC12-8G	3/4	19.05	1/2	11.93	1-1/16	26.98	1-1/8	28.58	24.38	21.84	38.86	14.22	49.02	26.00
DMC12-12G	3/4	19.05	3/4	15.74	1-5/16	33.33	1-1/8	28.58	24.38	21.84	42.67	15.75	52.83	32.00
DMC16-8G	1	25.40	1/2	11.93	1-3/8	34.92	1-1/2	38.10	31.24	26.41	43.69	14.22	55.88	26.00
DMC16-12G	1	25.40	3/4	15.74	1-3/8	34.92	1-1/2	38.10	31.24	26.41	43.69	15.75	55.88	32.00
DMC16-16G	1	25.40	1	22.35	1-5/8	41.27	1-1/2	38.10	31.24	26.41	47.75	18.29	59.94	39.00
DMC20-20G	1-1/4	31.75	1-1/4	27.68	2	50.80	1-7/8	47.63	41.14	38.86	51.16	20.00	73.26	49.00
DMC24-24G	1-1/2	38.10	1-1/2	34.03	2-1/4	57.15	2-1/4	57.15	50.03	45.21	57.57	22.00	84.75	54.70

Male Connector for Metal Gasket (previously DOM)
DMC-GB

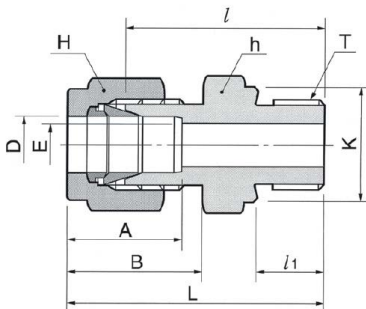

Connects fractional tube to female ISO parallel thread

Part No.	Tube O.D.D		T PF	E Min.	Width across flat				A	B	ℓ	ℓ1	L	K
	in.	mm			h		H							
					in.	mm	in.	mm						
DMC2-2GB	1/8	3.17	1/8	2.28	9/16	14.28	7/16	11.11	12.70	15.24	23.37	7.11	29.97	13.72
DMC2-4GB	1/8	3.17	1/4	2.28	3/4	19.05	7/16	11.11	12.70	15.24	28.70	11.18	35.31	18.03
DMC2-6GB	1/8	3.17	3/8	2.28	7/8	22.22	7/16	11.11	12.70	15.24	29.72	11.18	36.21	21.84
DMC4-2GB	1/4	6.35	1/8	2.28	9/16	14.28	9/16	14.28	15.24	17.78	24.89	7.11	32.26	13.72
DMC4-4GB	1/4	6.35	1/4	4.82	3/4	19.05	9/16	14.28	15.24	17.78	30.23	11.18	37.59	18.03
DMC4-6GB	1/4	6.35	3/8	4.82	7/8	22.22	9/16	14.28	15.24	17.78	31.50	11.18	38.86	21.84
DMC4-8GB	1/4	6.35	1/2	4.82	1-1/16	26.98	9/16	14.28	15.24	17.78	37.34	14.22	44.70	25.91
DMC6-4GB	3/8	9.52	1/4	4.82	3/4	19.05	11/16	17.46	16.76	19.30	31.75	11.18	39.12	18.03
DMC6-6GB	3/8	9.52	3/8	7.11	7/8	22.22	11/16	17.46	16.76	19.30	33.02	11.18	40.39	21.84
DMC6-8GB	3/8	9.52	1/2	7.11	1-1/16	26.98	11/16	17.46	16.76	19.30	38.86	14.22	46.23	25.91
DMC8-4GB	1/2	12.70	1/4	7.11	13/16	20.64	7/8	22.22	22.86	21.84	32.51	11.18	42.67	18.03
DMC8-6GB	1/2	12.70	3/8	9.65	7/8	22.22	7/8	22.22	22.86	21.84	33.02	11.18	43.18	21.84
DMC8-8GB	1/2	12.70	1/2	10.41	1-1/16	26.98	7/8	22.22	22.86	21.84	38.86	14.22	49.02	25.91
DMC12-8GB	3/4	19.05	1/2	11.93	1-1/16	26.98	1-1/8	28.58	24.38	21.84	38.86	14.22	49.02	25.91
DMC12-12GB	3/4	19.05	3/4	15.74	1-5/16	33.33	1-1/8	28.58	24.38	21.84	42.67	15.75	52.83	32.00
DMC16-8GB	1	25.40	1/2	11.93	1-3/8	34.92	1-1/2	38.10	31.24	26.41	43.69	14.22	55.88	25.91
DMC16-16GB	1	25.40	1	22.35	1-5/8	41.27	1-1/2	38.10	31.24	26.41	47.75	18.29	59.94	39.12
DMC20-20GB	1-1/4	31.75	1-1/4	27.68	2	50.80	1-7/8	47.63	41.14	38.86	51.16	20.00	73.26	49.00
DMC24-24GB	1-1/2	38.10	1-1/2	34.03	2-1/4	57.15	2-1/4	57.15	50.03	45.21	57.57	22.00	84.75	54.70

Male Connector for Metal Gasket (previously DOM)

DMC-GB, DMC-G

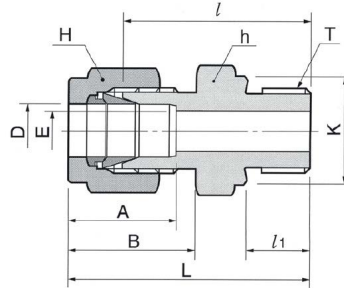

DMC-GB

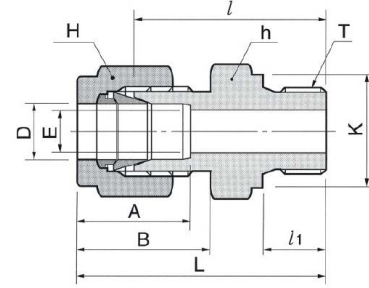

DMC-G

Connects metric tube to female ISO tapered thread

Part No.	Tube O.D. D	T PF	E Min.	Width across flat		A	B	ℓ	ℓ1	L	K
				h	H						
DMC3M-2GB(-2G)	3	1/8	2.4	14	12	12.9	15.3	23.4	7.1	30.0	13.8
DMC3M-4GB(-4G)	3	1/4	2.4	19	12	12.9	15.3	28.7	11.2	35.3	18.0
DMC4M-2GB(-2G)	4	1/8	2.4	14	12	13.7	16.1	24.1	7.1	30.7	13.8
DMC6M-2GB(-2G)	6	1/8	4.0	14	14	15.3	17.7	24.9	7.1	32.3	13.8
DMC6M-4GB(-4G)	6	1/4	4.8	19	14	15.3	17.7	30.2	11.2	37.6	18.0
DMC6M-6GB(-6G)	6	3/8	4.8	22	14	15.3	17.7	31.5	11.2	38.9	21.8
DMC6M-8GB(-8G)	6	1/2	4.8	27	14	15.3	17.7	37.3	14.2	44.7	26.0
DMC8M-2GB(-2G)	8	1/8	4.0	15	16	16.2	18.6	25.7	7.1	33.2	13.8
DMC8M-4GB(-4G)	8	1/4	6.4	19	16	16.2	18.6	31.0	11.2	38.5	13.8
DMC8M-6GB(-6G)	8	3/8	6.4	22	16	16.2	18.6	32.3	11.2	39.8	21.8
DMC8M-8GB(-8G)	8	1/2	6.4	27	16	16.2	18.6	38.1	14.2	45.6	26.0
DMC10M-4GB(-4G)	10	1/4	5.9	19	19	17.2	19.5	31.8	11.2	39.4	18.0
DMC10M-6GB(-6G)	10	3/8	7.9	22	19	17.2	19.5	33.0	11.2	40.6	21.8
DMC10M-8GB(-8G)	10	1/2	7.9	27	19	17.2	19.5	38.9	14.2	46.5	26.0
DMC12M-4GB(-4G)	12	1/4	5.9	22	22	22.8	22.0	32.5	11.2	42.6	18.0
DMC12M-6GB(-6G)	12	3/8	7.9	22	22	22.8	22.0	33	11.2	43.1	21.8
DMC12M-8GB(-8G)	12	1/2	9.5	27	22	22.8	22.0	38.9	14.2	49.0	26.0
DMC12M-12GB(-12G)	12	3/4	9.5	35	22	22.8	22.0	42.7	15.7	52.8	32.0
DMC15M-8GB(-8G)	15	1/2	11.9	27	25	24.4	22.0	33.9	14.2	49.0	26.0
DMC16M-6GB(-6G)	16	3/8	7.9	24	25	24.4	22.0	33.8	11.2	43.9	21.8
DMC16M-8GB(-8G)	16	1/2	11.9	27	25	24.4	22.0	38.9	14.2	49.0	26.0
DMC18M-8GB(-8G)	18	1/2	11.9	27	30	24.4	22.0	38.9	14.2	49.0	26.0
DMC18M-12GB(-12G)	18	3/4	15.1	35	30	24.4	22.0	42.7	15.7	52.8	32.0
DMC20M-8GB(-8G)	20	1/2	11.9	30	32	26.0	22.0	40.4	14.2	50.5	26.0
DMC20M-12GB(-12G)	20	3/4	15.9	35	32	26.0	22.0	42.7	15.7	52.8	32.0
DMC22M-12GB(-12G)	22	3/4	15.9	35	32	26.0	22.0	42.7	15.7	52.8	32.0
DMC22M-16GB(-16G)	22	1	18.3	41	32	26.0	22.0	45.2	18.3	55.3	39.0
DMC25M-12GB(-12G)	25	3/4	15.9	35	38	31.3	26.5	45.2	15.7	57.5	32.0
DMC25M-16GB(-16G)	25	1	19.8	41	38	31.3	26.5	47.8	18.3	60.1	39.0
DMC28M-16GB(-16G)	28	1	19.8	41	46	36.6	36.6	49.3	18.3	70.1	39.0
DMC28M-20GB(-20G)	28	1-1/4	21.8	50	46	36.6	36.6	53.1	19.8	73.9	49.0
DMC30M-20GB(-20G)	30	1-1/4	21.8	50	46	36.6	36.6	53.1	19.8	73.9	49.0
DMC32M-20GB(-20G)	32	1-1/4	28.6	50	50	42.0	41.6	55.9	19.8	78.9	49.0
DMC38M-24GB(-24G)	38	1-1/2	31.8	55	60	49.4	47.9	61.7	20.6	89.3	54.7

ISO Pipe Thread

The International Standards Organization prepares the ISO 228-1 and ISO 7-1 international standard to standardize the nomenclature of several international pipe threads.

ISO 228-1

ISO 228-1 represents internal and external parallel pipe threads where pressure-tight joints are not made on the threads. Compressing two tightening surfaces outside the threads or interposing a gasket seal will make the internal and external thread assembly pressure-tight joint.

ISO 228-1 standardizes the following international pipe threads.
1. BS 2779 (BSPP) 2. DIN-ISO 228/1 3. JIS B0202 (PF)

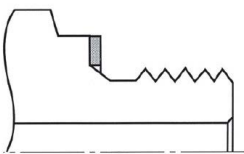

Sealing by compression against the face of the female threaded component.

Reference DIN 3852 Form A
See page on 9
for G end connection

A self-centering taper is constructed at male thread end. This taper centers a bonded gasket to seal up on the face of the female threaded component.

DGB: NBR inner ring bonded to carbon steel outer ring.
DGV: FKM inner ring bonded to stainless steel outer ring.

Part Number		E		H		D	
		mm	in.	mm	in.	mm	in.
DGB-2-C	DGV-2-S	10.4	0.41	2.0	0.08	16	0.63
DGB-4-C	DGV-4-S	13.7	0.54	2.0	0.08	20.6	0.81
DGB-6-C	DGV-6-S	17.3	0.68	2.0	0.08	23.9	0.94
DGB-8-C	DGV-8-S	21.6	0.85	2.5	0.1	28.7	1.13
DGB-12-C	DGV-12-S	26.9	1.06	2.5	0.1	35.1	1.38
DGB-16-C	DGV-16-S	33.8	1.33	2.5	0.1	42.9	1.69
DGB-20-C	DGV-20-S	42.4	1.67	2.5	0.1	51.05	2.01
DGB-24-C	DGV-24-S	48.8	1.92	2.5	0.1	59.18	2.33

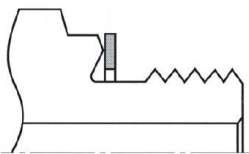
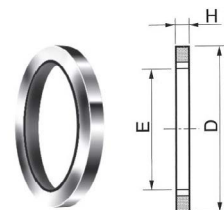

Sealing by gasket.
Reference DIN 3852 Form B

See page on 9
for GB end connection

A Metal Gasket performs the sealing between the reverse level of the fitting and the face of the female threaded component.

DGC Copper Gasket

Part Number		E		H		D	
		mm	in.	mm	in.	mm	in.
DGC-2-G		9.9	0.39	1.0	0.04	15.0	0.59
DGC-4-G		13.2	0.52	1.5	0.06	19.1	0.75
DGC-6-G		16.8	0.66	1.5	0.06	23.1	0.91
DGC-8-G		21.1	0.83	1.5	0.06	26.9	1.06
DGC12-G		26.7	1.05	2.0	0.08	33.0	1.30
DGC-16-G		33.3	1.31	2.0	0.08	40.1	1.58
DGC-20-G		42.2	1.66	2.0	0.08	49.8	1.96
DGC-24-G		48.0	1.89	2.0	0.08	58.4	2.30

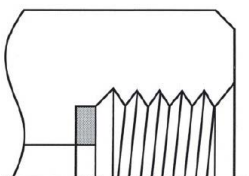
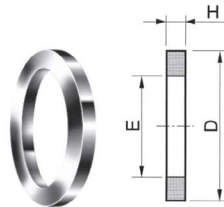

Sealing by gasket.
Reference DIN 3852 Form Y
See page on 9
for GY end connection

A gasket is dropped into the flat bottom of the female thread. The face of the male thread exerts a load on the gasket to seal

DGC Copper Gasket

Part Number		E		H		D	
		mm	in.	mm	in.	mm	in.
DGG-4-		7.6	0.30	1.8	0.07	10.7	0.42
DGG-6-		8.6	0.34	2.3	0.09	14.2	0.56
DGG-8-		9.1	0.36	2.5	0.10	17.8	0.70

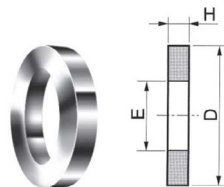

Gasket Temperature Ratings	Gasket	Material	Rated
	DGB	NBR	-40 to 110°C (-40 to 230°F)
	DGV	FKM	-28 to 204°C (-20 to 400°F)
	DGC, DGG	Copper	-198 to 204°C (-325 to 400°F)

ISO Internal Parallel Pipe Thread

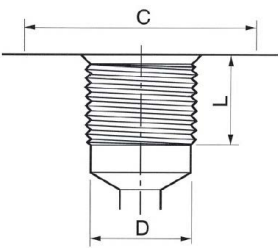

DK-Lok Pipe Thread Designator	ISO Female Parallel Pipe Size	Minimum Full Thread Depth L	Thread Minor Diameter D	Minimum Flat Diameter for DGB & DGC C
2	1/8	0.31	0.337/0.348	0.59
4	1/4	0.47	0.450/0.468	0.75
6	3/8	0.47	0.588/0.606	0.91
8	1/2	0.55	0.733/0.755	1.06
12	3/4	0.63	0.949/0.971	1.30
16	1	0.71	1.193/1.218	1.58

ISO 7-1

ISO 7-1 represents internal and external pipe tapered threads where pressure-tight joints are made by interference fit. This thread requires sealant to fill the voids between male and female threads that also prevents galling on threads. The sealant usually contains lubricant.

ISO 7-1 standardizes the following international pipe threads.
1. BS 21(BSPT) 2. JIS B0203(PT) 3.DIN 2999 (male thread only)

ISO 7-1 tapered pipe thread

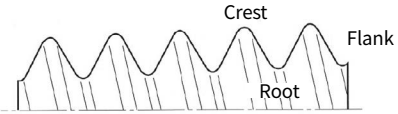

- 55° thread angle
- Pitch measured in millimeters
- Truncation of root and crest are round
- Taper angle 1° 47'

NPT tapered pipe thread

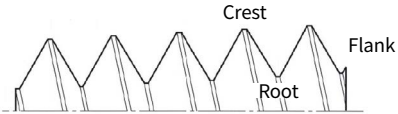

- 60° thread angle
- Pitch measured in inches
- Truncation of root and crest are flat
- Taper angle 1° 47'

Bulkhead Male Connector DMCB-N

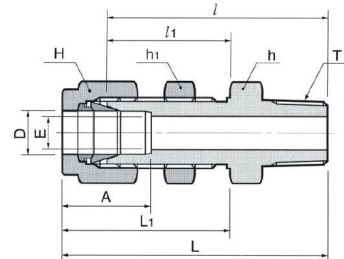

Connects fractional tube to female NPT thread

Part No.	Tube O.D. D		T NPT	TE Min.	Width across flat						A	ℓ	ℓ1	L	L1	Panel Hole Drill size	Panel Max Thickness
	in.	mm			h		h1		H								
					in.	mm	in.	mm	in.	mm							
DMCB2-2N	1/8	3.17	1/8	2.28	1/2	12.70	1/2	12.70	7/16	11.11	12.70	39.87	24.63	46.48	31.24	8.33	12.70
DMCB4-2N	1/4	6.35	1/8	4.82	5/8	15.87	5/8	15.87	9/16	14.28	15.24	42.16	26.16	49.53	33.52	11.50	10.16
DMCB4-4N	1/4	6.35	1/4	4.82	5/8	15.87	5/8	15.87	9/16	14.28	15.24	45.97	26.16	53.34	33.52	11.50	10.16
DMCB4-6N	1/4	6.35	3/8	4.8	3/4	19.05	5/8	15.87	9/16	14.28	15.24	45.97	26.16	53.34	33.52	11.50	10.16
DMCB4-8N	1/4	6.35	1/2	4.8	7/8	22.22	5/8	15.87	9/16	14.28	15.24	53.08	26.16	60.45	33.52	11.50	10.16
DMCB6-4N	3/8	9.52	1/4	7.11	3/4	19.05	3/4	19.05	11/16	17.46	16.76	50.03	29.46	57.40	36.83	14.68	11.17
DMCB6-6N	3/8	9.52	3/8	7.11	3/4	19.05	3/4	19.05	11/16	17.46	16.76	50.03	29.46	57.40	36.83	14.68	11.17
DMCB6-8N	3/8	9.52	1/2	7.11	7/8	22.22	3/4	19.05	11/16	17.46	16.76	56.38	29.46	63.75	36.83	14.68	11.17
DMCB8-6N	1/2	12.70	3/8	9.39	15/16	23.81	15/16	23.81	7/8	22.22	22.86	53.08	31.75	63.24	41.91	19.44	12.70
DMCB8-8N	1/2	12.70	1/2	10.41	15/16	23.81	15/16	23.81	7/8	22.22	22.86	58.67	31.75	68.83	41.91	19.44	12.70
DMCB10-6N	5/8	15.87	3/8	7.93	1-1/16	26.98	1-1/16	26.98	1	25.4	24.38	54.52	32.51	64.68	42.67	22.62	12.70
DMCB12-12N	3/4	19.05	3/4	15.74	1-3/16	30.16	1-3/16	30.16	1-1/8	28.58	24.38	66.04	37.33	76.20	47.49	25.76	16.76
DMCB16-16N	1	25.40	1	22.35	1-5/8	41.28	1-5/8	41.28	1-1/2	38.10	31.24	81.02	45.21	93.21	57.40	33.73	19.05
DMCB20-20N	1-1/4	31.75	1-1/4	27.68	1-7/8	47.63	1-7/8	47.63	1-7/8	47.63	41.14	85.97	47.75	108.07	69.85	41.67	19.05
DMCB24-24N	1-1/2	38.10	1-1/2	33.90	2-1/4	57.15	2-1/4	57.15	2-1/4	57.15	50.03	93.03	49.27	120.21	76.45	49.61	19.05
DMCB32-32N	2	50.80	2	45.97	2-3/4	69.85	2-3/4	69.85	3	76.20	67.56	107.29	56.38	144.62	93.71	16.27	19.05

Bulkhead Male Connector

DMCB-N

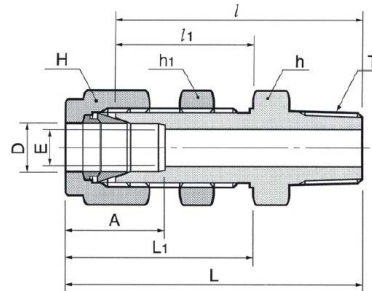

Connects metric tube to female NPT thread

Part No.	Tube O.D. D	T NPT	TE Min.	Width across flat			A	ℓ	ℓ1	L	L1	Panel Hole Drill size	Panel Max Thickness
				h	h1	H							
DMCB6M-2N	6	1/8	4.8	16	16	14	15.3	42.2	26.2	49.6	33.6	11.5	10.2
DMCB6M-4N	6	1/4	4.8	16	16	14	15.3	46.2	26.2	53.6	33.6	11.5	10.2
DMCB6M-6N	6	3/8	4.8	16	16	14	15.3	46.2	26.2	53.6	33.6	11.5	10.2
DMCB6M-8N	6	1/2	4.8	16	16	14	15.3	52.6	26.2	60.0	33.6	11.5	10.2
DMCB8M-6N	8	3/8	6.4	18	18	16	16.2	50.0	28.6	57.5	36.1	13.1	11.2
DMCB10M-4N	10	1/4	7.1	22	22	19	17.2	50.0	29.4	57.5	37.0	16.2	11.2
DMCB10M-6N	10	3/8	7.9	22	22	19	17.2	50.0	29.4	57.5	37.0	16.2	11.2
DMCB10M-8N	10	1/2	7.9	22	22	19	17.2	55.9	29.4	63.5	37.0	16.2	11.2
DMCB12M-6N	12	3/8	9.8	24	24	22	22.8	53.3	31.8	63.4	41.9	19.5	12.7
DMCB12M-8N	12	1/2	9.8	24	24	22	22.8	58.7	31.8	68.8	41.9	19.5	12.7

45° Male Elbow

DLBM

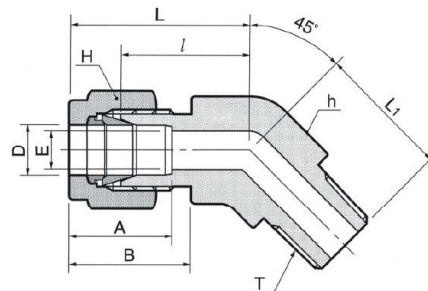

Connects fractional tube to female NPT thread

Part No.	Tube O.D. D		T NPT	E Min.	Width across flat				A	B	ℓ	L	L1
	in.	mm			h		H						
					in.	mm	in.	mm					
DLBM2-2N	1/8	3.17	1/8	2.4	1/2	12.70	7/16	11.11	12.70	15.24	15.77	22.38	16.51
DLBM4-2N	1/4	6.35	1/8	4.8	1/2	12.70	9/16	14.28	15.24	17.78	17.27	24.63	16.51
DLBM4-4N	1/4	6.35	1/4	4.8	1/2	12.70	9/16	14.28	15.24	17.78	17.27	24.63	21.08
DLBM6-2N	3/8	9.52	1/8	4.8	5/8	15.87	11/16	17.46	16.76	19.30	20.57	27.94	18.28
DLBM6-4N	3/8	9.52	1/4	7.11	5/8	15.87	11/16	17.46	16.76	19.30	20.57	27.94	22.86
DLBM6-6N	3/8	9.52	3/8	7.11	13/16	20.64	11/16	17.46	16.76	19.30	21.84	29.21	24.13
DLBM8-6N	1/2	12.70	3/8	9.65	13/16	20.64	7/8	22.22	22.86	21.84	21.84	32.00	24.13
DLBM8-8N	1/2	12.70	1/2	10.41	13/16	20.64	7/8	22.22	22.86	21.84	21.84	32.00	28.95
DLBM12-12N	3/4	19.05	3/4	15.74	1-1/8	28.58	1-1/8	28.58	24.38	21.84	23.87	34.03	30.98
DLBM16-16N	1	25.40	1	22.35	1-3/8	34.93	1-1/2	38.10	31.24	26.41	28.19	40.38	37.84

Connects metric tube to female NPT thread

Part No.	Tube O.D. D	T NPT	E Min.	Width across flat		A	B	ℓ	L	L1
				h	H					
DLBM6M-4N	6	1/4	4.8	12.7	14.0	15.3	17.7	21.8	29.4	22.9
DLBM12M-8N	12	1/2	9.5	20.64	22.0	22.8	22.0	21.8	31.9	29.0

Male Elbow
DLM-N

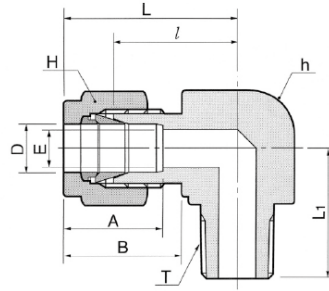
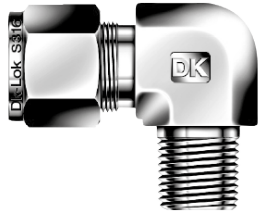

Connects fractional tube to female NPT thread

Part No.	Tube O.D. D		T NPT	E Min.	Width across flat				A	B	ℓ	L	L1
	in.	mm			h		H						
					in.	mm	in.	mm					
DLM1-1N	1/16	1.59	1/16	1.27	7/16	11.11	5/16	7.93	8.63	10.92	15.24	19.05	17.78
DLM1-2N	1/16	1.59	1/8	1.27	7/16	11.11	5/16	7.93	8.63	10.92	15.24	19.05	17.78
DLM2-1N	1/8	3.17	1/16	2.28	7/16	11.11	7/16	11.11	12.70	15.24	17.02	23.63	17.78
DLM2-2N	1/8	3.17	1/8	2.28	1/2	12.70	7/16	11.11	12.70	15.24	18.30	24.91	18.90
DLM2-4N	1/8	3.17	1/4	2.28	1/2	12.70	7/16	11.11	12.70	15.24	18.30	24.91	23.26
DLM3-2N	3/16	4.76	1/8	3.04	1/2	12.70	1/2	12.70	13.71	16.00	18.79	25.40	18.79
DLM3-4N	3/16	4.76	1/4	3.04	1/2	12.70	1/2	12.70	13.71	16.00	18.79	25.40	23.36
DLM4-1N	1/4	6.35	1/16	3.04	1/2	12.70	9/16	14.28	15.24	17.78	19.55	26.90	18.79
DLM4-2N	1/4	6.35	1/8	4.82	1/2	12.70	9/16	14.28	15.24	17.78	19.55	26.47	18.79
DLM4-4N	1/4	6.35	1/4	4.82	1/2	12.70	9/16	14.28	15.24	17.78	19.81	27.18	23.87
DLM4-6N	1/4	6.35	3/8	4.82	11/16	17.46	9/16	14.28	15.24	17.78	22.35	29.71	26.20
DLM4-8N	1/4	6.35	1/2	4.82	13/16	20.64	9/16	14.28	15.24	17.78	24.60	31.97	33.02
DLM5-2N	5/16	7.93	1/8	4.82	9/16	14.28	5/8	15.87	16.25	18.54	21.33	28.70	19.81
DLM5-4N	5/16	7.93	1/4	6.35	9/16	14.28	5/8	15.87	16.25	18.54	21.33	29.77	24.50
DLM5-6N	5/16	7.93	3/8	6.35	11/16	17.46	5/8	15.87	16.25	18.54	23.11	30.48	26.20
DLM6-2N	3/8	9.52	1/8	4.82	5/8	15.87	11/16	17.46	16.76	19.30	23.11	30.48	20.60
DLM6-4N	3/8	9.52	1/4	7.11	5/8	15.87	11/16	17.46	16.76	19.30	23.11	30.48	25.40
DLM6-6N	3/8	9.52	3/8	7.11	11/16	17.46	11/16	17.46	16.76	19.30	23.87	31.24	26.20
DLM6-8N	3/8	9.52	1/2	7.11	13/16	20.64	11/16	17.46	16.76	19.30	25.90	31.42	33.02
DLM6-12N	3/8	9.52	3/4	7.11	1-1/16	26.98	11/16	17.46	16.76	19.30	29.71	37.08	36.83
DLM8-4N	1/2	12.70	1/4	7.11	13/16	20.64	7/8	22.22	22.86	21.84	25.90	36.06	28.30
DLM8-6N	1/2	12.70	3/8	9.65	13/16	20.64	7/8	22.22	22.86	21.84	25.90	36.06	28.30
DLM8-8N	1/2	12.70	1/2	10.41	13/16	20.64	7/8	22.22	22.86	21.84	25.90	36.06	33.02
DLM8-12N	1/2	12.70	3/4	10.41	1-1/16	26.98	7/8	22.22	22.86	21.84	29.71	39.87	36.83
DLM10-6N	5/8	15.87	3/8	9.65	15/16	23.81	1	25.40	24.38	21.84	28.00	37.06	30.22
DLM10-8N	5/8	15.87	1/2	11.93	15/16	23.81	1	25.40	24.38	21.84	28.00	37.06	35.10
DLM10-12N	5/8	15.87	3/4	12.70	1-1/16	26.98	1	25.40	24.38	21.84	29.71	39.87	36.83
DLM12-8N	3/4	19.05	1/2	11.93	1-1/16	26.98	1-1/8	28.57	24.38	21.84	29.71	39.87	37.00
DLM12-12N	3/4	19.05	3/4	15.74	1-1/16	26.98	1-1/8	28.57	24.38	21.84	29.71	39.87	36.83
DLM14-12N	7/8	22.22	3/4	15.74	1-3/8	34.92	1-1/4	31.75	25.90	21.84	34.54	44.70	41.65
DLM16-12N	1	25.40	3/4	15.74	1-3/8	34.92	1-1/2	38.10	31.24	26.41	36.83	49.02	42.20
DLM16-16N	1	25.40	1	22.35	1-3/8	34.92	1-1/2	38.10	31.24	26.41	36.83	49.02	46.70
DLM20-20N	1-1/4	31.75	1-1/4	27.68	1-11/16	42.86	1-7/8	47.63	41.14	38.86	44.50	66.54	47.75
DLM24-24N	1-1/2	38.10	1-1/2	33.90	2	50.80	2-1/4	57.15	50.03	45.21	50.80	77.97	60.45
DLM32-32N	2	50.80	2	45.97	2-3/4	69.85	3	76.20	62.73	63.73	69.80	107.18	70.61

Male Elbow
DLM-N

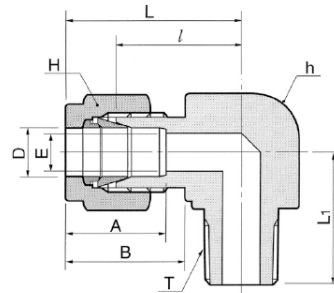
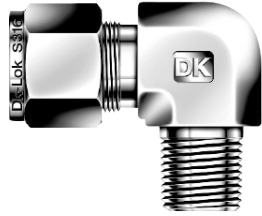

Connects metric tube to female NPT thread

Part No.	Tube O.D. D	T NPT	E Min.	Width across flat		A	B	ℓ	L	L1
				h	H					
DLM3M-1N	3	1/16	2.4	11.1	12	12.9	15.3	17.0	23.6	17.8
DLM3M-2N	3	1/8	2.4	12.7	12	12.9	15.3	17.0	23.6	17.8
DLM3M-4N	3	1/4	2.4	12.7	12	12.9	15.3	18.0	24.6	23.4
DLM4M-2N	4	1/8	2.4	12.7	12	13.7	16.1	18.8	25.4	18.8
DLM4M-4N	4	1/4	2.4	12.7	12	13.7	16.1	18.8	25.4	23.4
DLM6M-2N	6	1/8	4.8	12.7	14	15.3	17.7	19.6	27.0	18.8
DLM6M-4N	6	1/4	4.8	12.7	14	15.3	17.7	19.6	27.0	23.4
DLM6M-6N	6	3/8	4.8	17.5	14	15.3	17.7	22.4	29.8	26.2
DLM6M-8N	6	1/2	4.8	20.6	14	15.3	17.7	24.4	31.8	33.0
DLM8M-2N	8	1/8	4.8	14.3	16	16.2	18.6	21.3	28.8	19.8
DLM8M-4N	8	1/4	6.4	14.3	16	16.2	18.6	21.3	28.8	24.4
DLM8M-6N	8	3/8	6.4	17.5	16	16.2	18.6	23.1	30.6	26.2
DLM8M-8N	8	1/2	6.4	20.6	16	16.2	18.6	25.1	32.6	33.0
DLM10M-2N	10	1/8	4.8	17.5	19	17.2	19.5	23.9	31.5	23.6
DLM10M-4N	10	1/4	7.1	17.5	19	17.2	19.5	23.9	31.5	26.2
DLM10M-6N	10	3/8	7.9	17.5	19	17.2	19.5	23.9	31.5	26.2
DLM10M-8N	10	1/2	7.9	20.6	19	17.2	19.5	25.9	33.5	33.0
DLM12M-4N	12	1/4	7.1	20.6	22	22.8	22.0	25.9	36.0	28.2
DLM12M-6N	12	3/8	9.5	20.6	22	22.8	22.0	25.9	36.0	28.2
DLM12M-8N	12	1/2	9.5	20.6	22	22.8	22.0	25.9	36.0	33.0
DLM12M-12N	12	3/4	9.5	27.0	22	22.8	22.0	29.7	39.8	36.8
DLM15M-6N	15	3/8	9.5	23.81	25	24.4	22.0	27.9	38.0	30.2
DLM15M-8N	15	1/2	11.9	23.81	25	24.4	22.0	27.9	38.0	35.1
DLM16M-6N	16	3/8	9.5	25.4	25	24.4	22.0	27.9	38.0	30.2
DLM16M-8N	16	1/2	11.9	23.81	25	24.4	22.0	27.9	38.0	35.1
DLM16M-12N	16	3/4	12.7	23.81	25	24.4	22.0	29.7	39.8	36.8
DLM18M-8N	18	1/2	11.9	27.0	30	24.4	22.0	29.7	39.8	36.8
DLM18M-12N	18	3/4	15.1	27.0	30	24.4	22.0	29.7	39.8	36.8
DLM20M-8N	20	1/2	11.9	34.9	32	26.0	22.0	34.5	44.6	41.7
DLM20M-12N	20	3/4	15.9	34.9	32	26.0	22.0	34.5	44.6	41.7
DLM22M-8N	22	1/2	11.9	34.9	32	26.0	22.0	32.5	42.6	39.6
DLM22M-12N	22	3/4	15.9	34.9	32	26.0	22.0	34.5	44.6	41.7
DLM22M-16N	22	1	18.3	34.9	32	26.0	22.0	34.5	44.6	46.5
DLM25M-12N	25	3/4	15.9	34.9	38	31.3	26.5	36.8	49.1	41.7
DLM25M-16N	25	1	21.8	34.9	38	31.3	26.5	36.8	49.1	46.5
DLM28M-16N	28	1	21.8	41.0	46	36.6	36.6	43.2	64.0	53.7
DLM30M-20N	30	1-1/4	26.2	46.0	50	39.6	39.2	48.3	69.9	53.1
DLM32M-20N	32	1-1/4	27.8	46.0	50	42.0	41.6	49.3	72.3	53.1
DLM38M-24N	38	1-1/2	33.7	50.8	60	49.4	47.9	56.4	84.0	60.4

Male Elbow
DLM-R

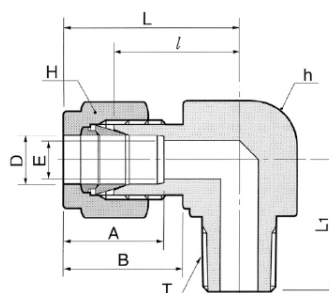

Connects fractional tube to female ISO tapered thread

Part No.	Tube O.D. D		T PT	E Min.	Width across flat				A	B	ℓ	L	L1
	in.	mm			h		H						
					in.	mm	in.	mm					
DLM2-2R	1/8	3.17	1/8	2.28	1/2	12.70	7/16	11.11	12.70	15.24	18.30	24.91	18.90
DLM2-4R	1/8	3.17	1/4	2.28	1/2	12.70	7/16	11.11	12.70	15.24	18.30	24.91	23.26
DLM3-4R	3/16	4.76	1/4	3.04	1/2	12.70	1/2	12.70	13.71	16.00	18.79	25.40	23.36
DLM4-2R	1/4	6.35	1/8	4.82	1/2	12.70	9/16	14.28	15.24	17.78	19.55	26.47	18.79
DLM4-4R	1/4	6.35	1/4	4.82	1/2	12.70	9/16	14.28	15.24	17.78	19.81	27.18	23.87
DLM4-6R	1/4	6.35	3/8	4.82	11/16	17.46	9/16	14.28	15.24	17.78	22.35	29.71	26.20
DLM4-8R	1/4	6.35	1/2	4.82	13/16	20.64	9/16	14.28	15.24	17.78	24.60	31.97	33.02
DLM5-4R	5/16	7.93	1/4	6.35	9/16	14.28	5/8	15.87	16.25	18.54	21.33	29.77	24.50
DLM5-6R	5/16	7.93	3/8	6.35	11/16	17.46	5/8	15.87	16.25	18.54	23.11	30.48	26.20
DLM6-2R	3/8	9.52	1/8	4.82	5/8	15.87	11/16	17.46	16.76	19.30	23.11	30.48	20.60
DLM6-4R	3/8	9.52	1/4	7.11	5/8	15.87	11/16	17.46	16.76	19.30	23.11	30.48	25.40
DLM6-6R	3/8	9.52	3/8	7.11	11/16	17.46	11/16	17.46	16.76	19.30	23.87	31.24	26.20
DLM6-8R	3/8	9.52	1/2	7.11	13/16	20.64	11/16	17.46	16.76	19.30	25.90	31.42	33.02
DLM6-12R	3/8	9.52	3/4	7.11	1-1/16	26.98	11/16	17.46	16.76	19.30	29.71	37.08	36.83
DLM8-4R	1/2	12.70	1/4	7.11	13/16	20.64	7/8	22.22	22.86	21.84	25.90	36.06	28.30
DLM8-6R	1/2	12.70	3/8	9.65	13/16	20.64	7/8	22.22	22.86	21.84	25.90	36.06	28.30
DLM8-8R	1/2	12.70	1/2	10.41	13/16	20.64	7/8	22.22	22.86	21.84	25.90	36.06	33.02
DLM8-12R	1/2	12.70	3/4	10.41	1-1/16	26.98	7/8	22.22	22.86	21.84	29.71	39.87	36.83
DLM10-6R	5/8	15.87	3/8	9.65	15/16	23.81	1	25.40	24.38	21.84	28.00	37.06	30.22
DLM10-8R	5/8	15.87	1/2	11.93	15/16	23.81	1	25.40	24.38	21.84	28.00	37.06	35.10
DLM10-12R	5/8	15.87	3/4	12.70	1-1/16	26.98	1	25.40	24.38	21.84	29.71	39.87	36.83
DLM12-8R	3/4	19.05	1/2	11.93	1-1/16	26.98	1-1/8	28.57	24.38	21.84	29.71	39.87	37.00
DLM12-12R	3/4	19.05	3/4	15.74	1-1/16	26.98	1-1/8	28.57	24.38	21.84	29.71	39.87	36.83
DLM12-16R	3/4	19.05	1	16.0	1-3/8	34.92	1-1/8	28.57	24.38	21.84	34.54	44.59	46.48
DLM16-12R	1	25.40	3/4	15.74	1-3/8	34.92	1-1/2	38.10	31.24	26.41	36.83	49.02	42.20
DLM16-16R	1	25.40	1	22.35	1-3/8	34.92	1-1/2	38.10	31.24	26.41	36.83	49.02	46.70
DLM20-12R	1-1/4	31.75	3/4	15.74	1-11/16	42.86	1-7/8	47.63	41.14	38.86	44.50	66.54	42.95
DLM20-20R	1-1/4	31.75	1-1/4	27.68	1-11/16	42.86	1-7/8	47.63	41.14	38.86	44.50	66.54	47.75

Male Elbow
DLM-R

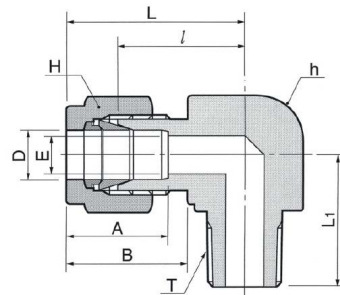

Connects metric tube to female ISO tapered thread

Part No.	Tube O.D. D	T NPT	E Min.	Width across flat		A	B	ℓ	L	L1
				h	H					
DLM3M-1R	3	1/16	2.4	11.1	12	12.9	15.3	17.0	23.6	17.8
DLM3M-2R	3	1/8	2.4	12.7	12	12.9	15.3	17.0	23.6	17.8
DLM3M-4R	3	1/4	2.4	12.7	12	12.9	15.3	18.0	24.6	23.4
DLM4M-2R	4	1/8	2.4	12.7	12	13.7	16.1	18.8	25.4	18.8
DLM4M-4R	4	1/4	2.4	12.7	12	13.7	16.1	18.8	25.4	23.4
DLM6M-2R	6	1/8	4.8	12.7	14	15.3	17.7	19.6	27.0	18.8
DLM6M-4R	6	1/4	4.8	12.7	14	15.3	17.7	19.6	27.0	23.4
DLM6M-6R	6	3/8	4.8	17.5	14	15.3	17.7	22.4	29.8	26.2
DLM6M-8R	6	1/2	4.8	20.6	14	15.3	17.7	24.4	31.8	33.0
DLM8M-2R	8	1/8	4.8	14.3	16	16.2	18.6	21.3	28.8	19.8
DLM8M-4R	8	1/4	6.4	14.3	16	16.2	18.6	21.3	28.8	24.4
DLM8M-6R	8	3/8	6.4	17.5	16	16.2	18.6	23.1	30.6	26.2
DLM8M-8R	8	1/2	6.4	20.6	16	16.2	18.6	25.1	32.6	33.0
DLM10M-2R	10	1/8	4.8	17.5	19	17.2	19.5	23.9	31.5	23.6
DLM10M-4R	10	1/4	7.1	17.5	19	17.2	19.5	23.9	31.5	26.2
DLM10M-6R	10	3/8	7.9	17.5	19	17.2	19.5	23.9	31.5	26.2
DLM10M-8R	10	1/2	7.9	20.6	19	17.2	19.5	25.9	33.5	33.0
DLM12M-2R	12	1/8	4.8	20.6	22	22.8	22.0	25.9	36.0	23.6
DLM12M-4R	12	1/4	7.1	20.6	22	22.8	22.0	25.9	36.0	28.2
DLM12M-6R	12	3/8	9.5	20.6	22	22.8	22.0	25.9	36.0	28.2
DLM12M-8R	12	1/2	9.5	20.6	22	22.8	22.0	25.9	36.0	33.0
DLM12M-12R	12	3/4	9.5	27.0	22	22.8	22.0	29.7	39.8	36.8
DLM14M-8R	14	1/2	11.1	23.81	25	24.4	22.0	27.9	38.0	30.2
DLM15M-6R	15	3/8	9.5	23.81	25	24.4	22.0	27.9	38.0	30.2
DLM15M-8R	15	1/2	11.9	23.81	25	24.4	22.0	27.9	38.0	35.1
DLM16M-6R	16	3/8	9.5	25.4	25	24.4	22.0	27.9	38.0	30.2
DLM16M-8R	16	1/2	11.9	23.81	25	24.4	22.0	27.9	38.0	35.1
DLM18M-8R	18	1/2	11.9	27.0	30	24.4	22.0	29.7	39.8	36.8
DLM18M-12R	18	3/4	15.1	27.0	30	24.4	22.0	29.7	39.8	36.8
DLM20M-8R	20	1/2	11.9	34.92	32	26.0	22.0	34.5	44.6	41.7
DLM20M-12R	20	3/4	15.9	34.92	32	26.0	22.0	34.5	44.6	41.7
DLM22M-8R	22	1/2	11.9	34.92	32	26.0	22.0	32.5	42.6	39.6
DLM22M-12R	22	3/4	15.9	34.92	32	26.0	22.0	34.5	44.6	41.7
DLM22M-16R	22	1	18.3	34.92	32	26.0	22.0	34.5	44.6	46.5
DLM25M-8R	25	1/2	11.9	34.92	38	31.3	26.5	36.8	49.1	41.7
DLM25M-12R	25	3/4	15.9	34.92	38	31.3	26.5	36.8	49.1	41.7
DLM25M-16R	25	1	21.8	34.92	38	31.3	26.5	36.8	49.1	46.5
DLM28M-16R	28	1	21.8	41.0	46	36.6	36.6	43.2	64.0	53.7

Male Elbow DTRM-N

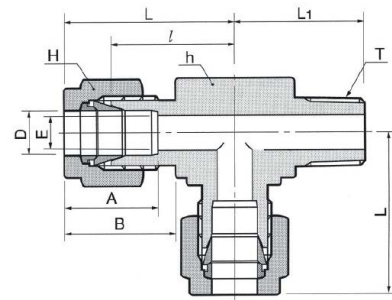

Connects fractional tube to female NPT thread

Part No.	Tube O.D. D		T PT	E Min.	Width across flat				A	B	ℓ	L	L1
	in.	mm			h		H						
					in.	mm	in.	mm					
DTRM1-1N	1/16	1.59	1/16	1.27	7/16	11.11	5/16	7.93	8.63	10.92	15.24	19.05	17.78
DTRM1-2N	1/16	1.59	1/8	1.27	7/16	11.11	5/16	7.93	8.63	10.92	15.24	19.05	17.78
DTRM2-2N	1/8	3.17	1/8	2.28	1/2	12.70	7/16	11.11	12.70	15.24	18.30	24.91	18.90
DTRM2-4N	1/8	3.17	1/4	2.28	1/2	12.70	7/16	11.11	12.70	15.24	18.30	24.91	23.26
DTRM3-2N	3/16	4.76	1/8	3.04	1/2	12.70	1/2	12.70	13.71	16.00	18.79	24.38	18.79
DTRM3-4N	3/16	4.76	1/4	3.04	1/2	12.70	1/2	12.70	13.71	16.00	18.79	25.40	23.36
DTRM4-1N	1/4	6.35	1/16	3.04	1/2	12.70	9/16	14.28	15.24	17.78	19.55	26.90	18.79
DTRM4-2N	1/4	6.35	1/8	4.82	1/2	12.70	9/16	14.28	15.24	17.78	19.55	26.92	18.79
DTRM4-4N	1/4	6.35	1/4	4.82	1/2	12.70	9/16	14.28	15.24	17.78	19.55	27.08	23.87
DTRM4-6N	1/4	6.35	3/8	4.82	11/16	17.46	9/16	14.28	15.24	17.78	22.35	29.71	28.40
DTRM4-8N	1/4	6.35	1/2	4.82	13/16	20.64	9/16	14.28	15.24	17.78	24.60	31.97	35.10
DTRM5-2N	5/16	7.93	1/8	4.82	9/16	14.28	5/8	15.87	16.25	18.54	22.35	29.71	19.81
DTRM5-4N	5/16	7.94	1/4	6.35	9/16	14.28	5/8	15.87	16.25	18.54	22.35	29.77	24.50
DTRM5-6N	5/16	7.94	3/8	6.35	11/16	17.46	5/8	15.87	16.25	18.54	23.11	30.48	28.40
DTRM6-4N	3/8	9.52	1/4	7.11	5/8	15.87	1/16	17.46	16.76	19.30	23.11	30.48	25.40
DTRM6-6N	3/8	9.52	3/8	7.11	11/16	17.46	11/16	17.46	16.76	19.30	23.87	31.24	28.44
DTRM6-8N	3/8	9.52	1/2	7.11	13/16	20.64	11/16	17.46	16.76	19.30	25.90	33.27	33.02
DTRM6-12N	3/8	9.52	3/4	7.11	1-1/16	26.98	11/16	17.46	16.76	19.30	29.71	37.08	36.83
DTRM8-4N	1/2	12.70	1/4	7.11	13/16	20.64	7/8	22.22	22.86	21.84	25.90	36.06	28.30
DTRM8-6N	1/2	12.70	3/8	9.65	13/16	20.64	7/8	22.22	22.86	21.84	25.90	36.06	28.30
DTRM8-8N	1/2	12.70	1/2	10.41	13/16	20.64	7/8	22.22	22.86	21.84	25.90	36.06	33.02
DTRM8-12N	1/2	12.70	3/4	10.41	1-1/16	26.98	7/8	22.22	22.86	21.84	29.71	39.84	36.83
DTRM10-6N	5/8	15.87	3/8	9.65	15/16	23.81	1	25.40	24.38	21.84	27.90	38.10	29.40
DTRM10-8N	5/8	15.87	1/2	11.93	15/16	23.81	1	25.40	24.38	21.84	27.90	38.10	34.00
DTRM10-12N	5/8	15.87	3/4	12.70	1-1/16	26.98	1	25.40	24.38	21.84	29.71	39.87	36.83
DTRM12-8N	3/4	19.05	1/2	11.93	1-1/16	26.98	1-1/8	28.58	24.38	21.84	29.71	39.87	37.00
DTRM12-12N	3/4	19.05	3/4	15.74	1-1/16	26.98	1-1/8	28.58	24.38	21.84	29.71	39.81	36.83
DTRM14-12N	7/8	22.23	3/4	15.74	1-3/8	34.92	1-1/4	31.75	25.90	21.84	34.54	44.70	41.65
DTRM16-12N	1	25.40	3/4	15.74	1-3/8	34.92	1-1/2	38.10	31.24	26.41	36.83	49.02	42.20
DTRM16-16N	1	25.40	1	22.35	1-3/8	34.92	1-1/2	38.10	31.24	26.41	36.83	49.02	46.70
DTRM20-20N	1-1/4	31.75	1-1/4	27.68	1-11/16	42.86	1-7/8	47.63	41.14	38.86	44.50	66.54	47.75
DTRM24-24N	1-1/2	38.10	1-1/2	33.90	2	50.80	2-1/4	57.15	50.03	45.21	50.80	77.97	60.45
DTRM32-32N	2	50.80	2	45.97	2-3/4	69.85	3	76.20	67.56	62.73	69.80	107.18	70.61

Male Run Tee
DTRM-R

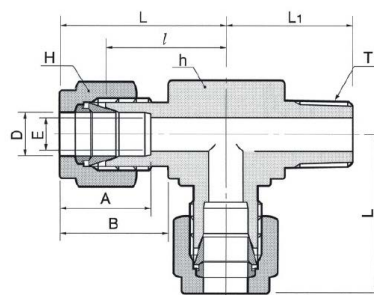

Connects fractional tube to female ISO tapered thread

Part No.	Tube O.D. D		T PT	E Min.	Width across flat				A	B	ℓ	L	L1
	in.	mm			h		H						
					in.	mm	in.	mm					
DTRM6-4R	3/8	9.52	1/4	7.11	5/8	15.87	1/16	17.46	16.76	19.30	23.11	30.48	25.40
DTRM8-6R	1/2	12.70	3/8	9.65	13/16	20.64	7/8	22.22	22.86	21.84	25.90	36.06	28.30
DTRM8-8R	1/2	12.70	1/2	10.41	13/16	20.64	7/8	22.22	22.86	21.84	25.90	36.06	33.02
DTRM10-8R	5/8	15.87	1/2	11.93	15/16	23.81	1	25.40	24.38	21.84	27.90	38.10	34.00

Connects metric tube to female ISO tapered thread

Part No.	Tube O.D. D	T NPT	E Min.	Width across flat		A	B	ℓ	L	L1
				h	H					
DTRM3M-2R	3	1/8	2.4	12.7	12	12.9	15.3	17.0	23.6	17.8
DTRM3M-4R	3	1/4	2.4	12.7	12	12.9	15.3	18.0	24.6	23.4
DTRM4M-2R	4	1/8	2.4	12.7	12	13.7	16.1	18.8	25.4	18.8
DTRM4M-4R	4	1/4	2.4	12.7	12	13.7	16.1	18.8	25.4	23.4
DTRM6M-2R	6	1/8	4.8	12.7	14	15.3	17.7	19.6	27.0	18.8
DTRM6M-4R	6	1/4	4.8	14.2	14	15.3	17.7	19.6	27.0	23.4
DTRM6M-6R	6	3/8	4.8	17.5	14	15.3	17.7	22.4	29.8	26.2
DTRM6M-8R	6	1/2	4.8	20.6	14	15.3	17.7	24.4	31.8	33.0
DTRM8M-2R	8	1/8	4.8	14.3	16	16.2	18.6	21.3	28.8	19.8
DTRM8M-4R	8	1/4	6.4	14.3	16	16.2	18.6	21.3	28.8	24.4
DTRM8M-6R	8	3/8	6.4	17.5	16	16.2	18.6	23.1	30.6	26.2
DTRM8M-8R	8	1/2	6.4	20.6	16	16.2	18.6	25.1	32.6	33.0
DTRM10M-2R	10	1/8	4.8	17.5	19	17.2	19.5	23.9	31.5	23.6
DTRM10M-4R	10	1/4	7.1	17.5	19	17.2	19.5	23.9	31.5	26.2
DTRM10M-6R	10	3/8	7.9	17.5	19	17.2	19.5	23.9	31.5	26.2
DTRM10M-8R	10	1/2	7.9	20.6	19	17.2	19.5	25.9	33.5	33.0
DTRM12M-2R	12	1/8	4.8	20.6	22	22.8	22.0	25.9	36.0	23.6
DTRM12M-4R	12	1/4	7.1	20.6	22	22.8	22.0	25.9	36.0	28.2
DTRM12M-6R	12	3/8	9.5	20.6	22	22.8	22.0	25.9	36.0	28.2
DTRM12M-8R	12	1/2	9.5	20.6	22	22.8	22.0	25.9	36.0	33.0
DTRM12M-12R	12	3/4	9.5	27.0	22	22.8	22.0	29.7	39.8	36.8
DTRM16M-6R	16	3/8	9.5	25.4	25	24.4	22.0	27.9	38.0	30.2
DTRM16M-8R	16	1/2	11.9	25.4	25	24.4	22.0	27.9	38.0	35.1
DTRM16M-12R	16	3/4	12.7	27.0	25	24.4	22.0	29.7	39.8	36.8
DTRM18M-8R	18	1/2	11.9	27.0	30	24.4	22.0	29.7	39.8	36.8
DTRM18M-12R	18	3/4	15.1	27.0	30	24.4	22.0	29.7	39.8	36.8
DTRM20M-8R	20	1/2	11.9	34.92	32	26.0	22.0	34.5	44.6	41.7
DTRM20M-12R	20	3/4	15.9	34.92	32	26.0	22.0	34.5	44.6	41.7
DTRM22M-12R	22	3/4	15.9	34.92	32	26.0	22.0	34.5	44.6	41.7
DTRM22M-16R	22	1	18.3	34.92	32	26.0	22.0	34.5	44.6	46.5
DTRM25M-12R	25	3/4	15.9	34.92	38	31.3	26.5	36.8	49.1	41.7
DTRM25M-16R	25	1	21.8	34.92	38	31.3	26.5	36.8	49.1	46.5

Male Branch Tee
DTBM-N, -R

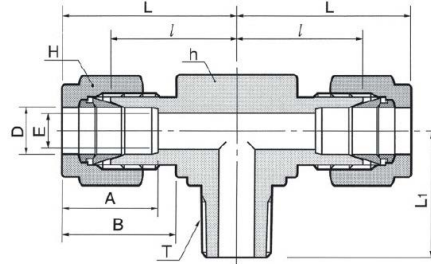

Connects fractional tube to female NPT thread

Part No.	Tube O.D. D		T PT	E Min.	Width across flat				A	B	ℓ	L	L1
	in.	mm			h		H						
					in.	mm	in.	mm					
DTBM1-1N	1/16	1.59	1/16	1.27	7/16	11.11	5/16	7.93	8.63	10.92	15.24	19.05	17.78
DTBM1-2N	1/16	1.59	1/8	1.27	7/16	11.11	5/16	7.93	8.63	10.92	15.24	19.05	17.78
DTBM2-2N	1/8	3.17	1/8	2.28	1/2	12.70	7/16	11.11	12.70	15.24	18.30	24.91	18.90
DTBM2-4N	1/8	3.17	1/4	2.28	1/2	12.70	7/16	11.11	12.70	15.24	18.30	24.91	23.36
DTBM3-2N	3/16	4.76	1/8	3.04	1/2	12.70	1/2	12.70	13.71	16.00	18.79	24.38	18.79
DTBM3-4N	3/16	4.76	1/4	3.04	1/2	12.70	1/2	12.70	13.71	16.00	18.79	25.40	23.36
DTBM4-1N	1/4	6.35	1/16	3.04	1/2	12.70	9/16	14.28	15.24	17.78	19.55	26.90	18.79
DTBM4-2N	1/4	6.35	1/8	4.82	1/2	12.70	9/16	14.28	15.24	17.78	19.55	26.92	19.10
DTBM4-4N	1/4	6.35	1/4	4.82	1/2	12.70	9/16	14.28	15.24	17.78	19.55	27.08	23.87
DTBM4-6N	1/4	6.35	3/8	4.82	11/16	17.46	9/16	14.28	15.24	17.78	22.35	29.71	28.40
DTBM4-8N	1/4	6.35	1/2	4.82	13/16	20.64	9/16	14.28	15.24	17.78	24.60	31.97	35.10
DTBM5-2N	5/16	7.93	1/8	4.82	9/16	14.28	5/8	15.87	16.25	18.54	22.35	29.71	19.81
DTBM5-4N	5/16	7.93	1/4	6.35	9/16	14.28	5/8	15.87	16.25	18.54	22.35	29.77	24.50
DTBM5-6N	5/16	7.93	3/8	6.35	11/16	17.46	5/8	15.87	16.25	18.54	23.11	30.48	28.40
DTBM6-4N	3/8	9.52	1/4	7.11	5/8	15.87	11/16	17.46	16.76	19.30	23.11	30.48	25.40
DTBM6-6N	3/8	9.52	3/8	7.11	11/16	17.46	11/16	17.46	16.76	19.30	23.87	31.24	28.44
DTBM6-8N	3/8	9.52	1/2	7.11	13/16	20.64	11/16	17.46	16.76	19.30	25.90	33.27	33.02
DTBM6-12N	3/8	9.52	3/4	7.11	1-1/16	26.98	11/16	17.46	16.76	19.30	29.71	37.08	36.83
DTBM8-4N	1/2	12.70	1/4	7.11	13/16	20.64	7/8	22.22	22.86	21.84	25.90	36.06	28.30
DTBM8-6N	1/2	12.70	3/8	10.41	13/16	20.64	7/8	22.22	22.86	21.84	25.90	36.06	28.30
DTBM8-8N	1/2	12.70	1/2	10.41	13/16	20.64	7/8	22.22	22.86	21.84	25.90	36.06	33.02
DTBM8-12N	1/2	12.70	3/4	10.41	1-1/16	26.98	7/8	22.22	22.86	21.84	29.71	39.87	36.83
DTBM10-6N	5/8	15.87	3/8	9.65	15/16	23.81	1	25.40	24.38	21.84	27.90	38.10	29.40
DTBM10-8N	5/8	15.87	1/2	11.93	15/16	23.81	1	25.40	24.38	21.84	27.90	38.10	34.00
DTBM10-12N	5/8	15.87	3/4	12.70	1-1/16	26.98	1	25.40	24.38	21.84	29.71	39.87	36.83
DTBM12-8N	3/4	19.05	1/2	11.93	1-1/16	26.98	1-1/8	28.58	24.38	21.84	29.71	39.87	37.00
DTBM12-12N	3/4	19.05	3/4	15.74	1-1/16	26.98	1-1/8	28.58	24.38	21.84	29.71	39.87	36.83
DTBM14-12N	7/8	22.22	3/4	15.74	1-3/8	34.92	1-1/4	31.75	25.90	21.84	34.54	44.70	41.65
DTBM16-12N	1	25.40	3/4	15.74	1-3/8	34.92	1-1/2	38.10	31.24	26.41	36.83	49.02	42.20
DTBM16-16N	1	25.40	1	22.35	1-3/8	34.92	1-1/2	38.10	31.24	26.41	36.83	49.02	46.70
DTBM20-20N	1-1/4	31.75	1-1/4	27.68	1-11/16	42.86	1-7/8	47.63	41.14	38.86	44.50	66.54	47.75
DTBM24-24N	1-1/2	38.10	1-1/2	33.90	2	50.80	2-1/4	57.15	50.03	45.21	50.80	77.97	60.45
DTBM32-32N	2	50.80	2	45.97	2-3/4	69.85	3	76.20	67.56	62.73	69.80	107.18	70.61

Connects fractional tube to female ISO tapered thread

Part No.	Tube O.D. D		T PT	E Min.	Width across flat				A	B	ℓ	L	L1
	in.	mm			h		H						
					in.	mm	in.	mm					
DTBM6-4R	3/8	9.52	1/4	7.11	5/8	15.87	1/16	17.46	16.76	19.30	23.11	30.48	25.40
DTBM8-6R	1/2	12.70	3/8	9.65	13/16	20.64	7/8	22.22	22.86	21.84	25.90	36.06	28.30
DTBM8-8R	1/2	12.70	1/2	10.41	13/16	20.64	7/8	22.22	22.86	21.84	25.90	36.06	33.02
DTBM10-8R	5/8	15.87	1/2	11.93	15/16	23.81	1	25.40	24.38	21.84	27.90	38.10	34.00

Male Branch Tee
DTBM-N

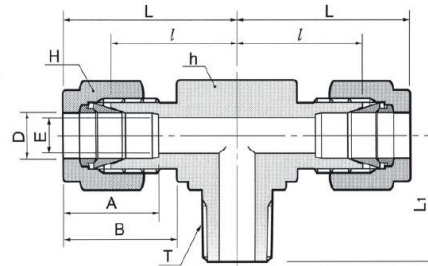

Connects metric tube to female NPT thread

Part No.	Tube O.D. D	T NPT	E Min.	Width across flat		A	B	ℓ	L	L1
				h	H					
DTBM3M-2N	3	1/8	2.4	12.7	12	12.9	15.3	17.0	23.6	17.8
DTBM3M-4N	3	1/4	2.4	12.7	12	12.9	15.3	18.0	24.6	23.4
DTBM4M-2N	4	1/8	2.4	12.7	12	13.7	16.1	18.8	25.4	18.8
DTBM4M-4N	4	1/4	2.4	12.7	12	13.7	16.1	18.8	25.4	23.4
DTBM6M-2N	6	1/8	4.8	12.7	14	15.3	17.7	19.6	27.0	18.8
DTBM6M-4N	6	1/4	4.8	14.2	14	15.3	17.7	19.6	27.0	23.4
DTBM6M-6N	6	3/8	4.8	17.5	14	15.3	17.7	22.4	29.8	26.2
DTBM6M-8N	6	1/2	4.8	20.6	14	15.3	17.7	24.4	31.8	33.0
DTBM8M-2N	8	1/8	4.8	14.3	16	16.2	18.6	21.3	28.8	19.8
DTBM8M-4N	8	1/4	6.4	14.3	16	16.2	18.6	21.3	28.8	24.4
DTBM8M-6N	8	3/8	6.4	17.5	16	16.2	18.6	23.1	30.6	26.2
DTBM8M-8N	8	1/2	6.4	20.6	16	16.2	18.6	25.1	32.6	33.0
DTBM10M-2N	10	1/8	4.8	17.5	19	17.2	19.5	23.9	31.5	23.6
DTBM10M-4N	10	1/4	7.1	17.5	19	17.2	19.5	23.9	31.5	26.2
DTBM10M-6N	10	3/8	7.9	17.5	19	17.2	19.5	23.9	31.5	26.2
DTBM10M-8N	10	1/2	7.9	20.6	19	17.2	19.5	25.9	33.5	33.0
DTBM12M-2N	12	1/8	4.8	20.6	22	22.8	22.0	25.9	36.0	23.6
DTBM12M-4N	12	1/4	7.1	20.6	22	22.8	22.0	25.9	36.0	28.2
DTBM12M-6N	12	3/8	9.5	20.6	22	22.8	22.0	25.9	36.0	28.2
DTBM12M-8N	12	1/2	9.5	20.6	22	22.8	22.0	25.9	36.0	33.0
DTBM12M-12N	12	3/4	9.5	27.0	22	22.8	22.0	29.7	39.8	36.8
DTBM16M-6N	16	3/8	9.5	25.4	25	24.4	22.0	27.9	38.0	30.2
DTBM16M-8N	16	1/2	11.9	25.4	25	24.4	22.0	27.9	38.0	35.1
DTBM16M-12N	16	3/4	12.7	27.0	25	24.4	22.0	29.7	39.8	36.8
DTBM18M-8N	18	1/2	11.9	27.0	30	24.4	22.0	29.7	39.8	36.8
DTBM18M-12N	18	3/4	15.1	27.0	30	24.4	22.0	29.7	39.8	36.8
DTBM20M-8N	20	1/2	11.9	34.92	32	26.0	22.0	34.5	44.6	41.7
DTBM20M-12N	20	3/4	15.9	34.92	32	26.0	22.0	34.5	44.6	41.7
DTBM22M-12N	22	3/4	15.9	34.92	32	26.0	22.0	34.5	44.6	41.7
DTBM22M-16N	22	1	18.3	34.92	32	26.0	22.0	34.5	44.6	46.5
DTBM25M-12N	25	3/4	15.9	34.92	38	31.3	26.5	36.8	49.1	41.7
DTBM25M-16N	25	1	21.8	34.92	38	31.3	26.5	36.8	49.1	46.5

Male Branch Tee DTBM -R

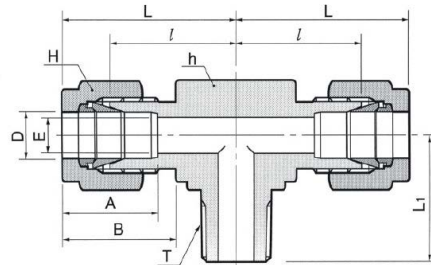

Connects metric tube to female ISO tapered thread

Part No.	Tube O.D. D	T NPT	E Min.	Width across flat		A	B	ℓ	L	L1
				h	H					
DTBM3M-2R	3	1/8	2.4	12.7	12	12.9	15.3	17.0	23.6	17.8
DTBM3M-4R	3	1/4	2.4	12.7	12	12.9	15.3	18.0	24.6	23.4
DTBM4M-2R	4	1/8	2.4	12.7	12	13.7	16.1	18.8	25.4	18.8
DTBM4M-4R	4	1/4	2.4	12.7	12	13.7	16.1	18.8	25.4	23.4
DTBM6M-2R	6	1/8	4.8	12.7	14	15.3	17.7	19.6	27.0	18.8
DTBM6M-4R	6	1/4	4.8	14.2	14	15.3	17.7	19.6	27.0	23.4
DTBM6M-6R	6	3/8	4.8	17.5	14	15.3	17.7	22.4	29.8	26.2
DTBM6M-8R	6	1/2	4.8	20.6	14	15.3	17.7	24.4	31.8	33.0
DTBM8M-2R	8	1/8	4.8	14.3	16	16.2	18.6	21.3	28.8	19.8
DTBM8M-4R	8	1/4	6.4	14.3	16	16.2	18.6	21.3	28.8	24.4
DTBM8M-6R	8	3/8	6.4	17.5	16	16.2	18.6	23.1	30.6	26.2
DTBM8M-8R	8	1/2	6.4	20.6	16	16.2	18.6	25.1	32.6	33.0
DTBM10M-2R	10	1/8	4.8	17.5	19	17.2	19.5	23.9	31.5	23.6
DTBM10M-4R	10	1/4	7.1	17.5	19	17.2	19.5	23.9	31.5	26.2
DTBM10M-6R	10	3/8	7.9	17.5	19	17.2	19.5	23.9	31.5	26.2
DTBM10M-8R	10	1/2	7.9	20.6	19	17.2	19.5	25.9	33.5	33.0
DTBM12M-2R	12	1/8	4.8	20.6	22	22.8	22.0	25.9	36.0	23.6
DTBM12M-4R	12	1/4	7.1	20.6	22	22.8	22.0	25.9	36.0	28.2
DTBM12M-6R	12	3/8	9.5	20.6	22	22.8	22.0	25.9	36.0	28.2
DTBM12M-8R	12	1/2	9.5	20.6	22	22.8	22.0	25.9	36.0	33.0
DTBM12M-12R	12	3/4	9.5	27.0	22	22.8	22.0	29.7	39.8	36.8
DTBM16M-6R	16	3/8	9.5	25.4	25	24.4	22.0	27.9	38.0	30.2
DTBM16M-8R	16	1/2	11.9	25.4	25	24.4	22.0	27.9	38.0	35.1
DTBM16M-12R	16	3/4	12.7	27.0	25	24.4	22.0	29.7	39.8	36.8
DTBM18M-8R	18	1/2	11.9	27.0	30	24.4	22.0	29.7	39.8	36.8
DTBM18M-12R	18	3/4	15.1	27.0	30	24.4	22.0	29.7	39.8	36.8
DTBM20M-8R	20	1/2	11.9	34.92	32	26.0	22.0	34.5	44.6	41.7
DTBM20M-12R	20	3/4	15.9	34.92	32	26.0	22.0	34.5	44.6	41.7
DTBM22M-12R	22	3/4	15.9	34.92	32	26.0	22.0	34.5	44.6	41.7
DTBM22M-16R	22	1	18.3	34.92	32	26.0	22.0	34.5	44.6	46.5
DTBM25M-12R	25	3/4	15.9	34.92	38	31.3	26.5	36.8	49.1	41.7
DTBM25M-16R	25	1	21.8	34.92	38	31.3	26.5	36.8	49.1	46.5

Female Connector
DCF-N

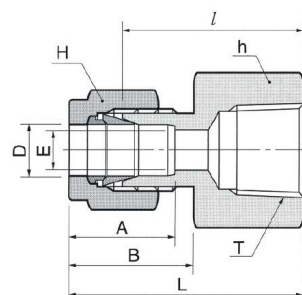
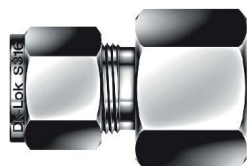

Connects fractional tube to male NPT thread

Part No.	Tube O.D. D		T NPT	E Min.	Width across flat				A	B	ℓ	L
	in.	mm			h		H					
					in.	mm	in.	mm				
DCF1-1N	1/16	1.59	1/16	1.27	7/16	11.11	5/16	7.93	8.63	10.92	19.81	23.62
DCF1-2N	1/16	1.59	1/8	1.27	9/16	14.28	5/16	7.93	8.63	10.92	20.57	24.38
DCF2-2N	1/8	3.17	1/8	2.28	9/16	14.28	7/16	11.11	12.70	15.24	22.09	28.70
DCF2-4N	1/8	3.17	1/4	2.28	3/4	19.05	7/16	11.11	12.70	15.24	26.92	33.52
DCF3-2N	3/16	4.76	1/8	3.04	9/16	14.28	1/2	12.70	13.71	16.00	23.11	29.71
DCF4-2N	1/4	6.35	1/8	4.82	9/16	14.28	9/16	14.28	15.24	17.78	23.87	31.24
DCF4-4N	1/4	6.35	1/4	4.82	3/4	19.05	9/16	14.28	15.24	17.78	28.44	35.81
DCF4-6N	1/4	6.35	3/8	4.82	7/8	22.22	9/16	14.28	15.24	17.78	30.22	37.59
DCF4-8N	1/4	6.35	1/2	4.82	1-1/16	26.98	9/16	14.28	15.24	17.78	35.05	42.41
DCF5-2N	5/16	7.93	1/8	6.35	9/16	14.28	5/8	15.87	16.25	18.54	24.63	32.00
DCF5-4N	5/16	7.93	1/4	6.35	3/4	19.05	5/8	15.87	16.25	18.54	29.46	36.83
DCF6-2N	3/8	9.52	1/8	7.11	5/8	15.87	11/16	17.46	16.76	19.30	25.40	32.76
DCF6-4N	3/8	9.52	1/4	7.11	3/4	19.05	11/16	17.46	16.76	19.30	30.22	37.59
DCF6-6N	3/8	9.52	3/8	7.11	7/8	22.22	11/16	17.46	16.76	19.30	31.75	39.11
DCF6-8N	3/8	9.52	1/2	7.11	1-1/16	26.98	11/16	17.46	16.76	19.30	36.57	43.94
DCF6-12N	3/8	9.52	3/4	7.11	1-5/16	33.33	11/16	17.46	16.76	19.30	40.38	47.75
DCF8-4N	1/2	12.70	1/4	10.41	1-3/16	20.64	7/8	22.22	22.86	21.84	30.22	40.38
DCF8-6N	1/2	12.70	3/8	10.41	7/8	22.22	7/8	22.22	22.86	21.84	31.75	41.91
DCF8-8N	1/2	12.70	1/2	10.41	1-1/16	26.98	7/8	22.22	22.86	21.84	36.57	46.73
DCF8-12N	1/2	12.70	3/4	10.41	1-5/16	33.33	7/8	22.22	22.86	21.84	38.10	48.26
DCF10-6N	5/8	15.87	3/8	12.70	15/16	23.81	1	25.40	24.38	21.84	31.75	41.91
DCF10-8N	5/8	15.87	1/2	12.70	1-1/16	26.98	1	25.40	24.38	21.84	36.57	46.73
DCF10-12N	5/8	15.87	3/4	12.70	1-5/16	33.33	1	25.40	24.38	21.84	38.10	48.26
DCF12-8N	3/4	19.05	1/2	15.74	1-1/16	26.98	1-1/8	28.58	24.38	21.84	36.57	46.73
DCF12-12N	3/4	19.05	3/4	15.74	1-5/16	33.33	1-1/8	28.58	24.38	21.84	38.10	48.26
DCF14-12N	7/8	22.22	3/4	18.28	1-5/16	33.33	1-1/4	31.75	25.90	21.84	39.62	49.78
DCF16-12N	1	25.40	3/4	22.35	1-3/8	34.92	1-1/2	38.10	31.24	26.41	41.14	53.34
DCF16-16N	1	25.40	1	22.35	1-5/8	41.27	1-1/2	38.10	31.24	26.41	50.03	62.23
DCF20-20N	1-1/4	31.75	1-1/4	27.68	2-1/8	53.98	1-7/8	47.63	41.14	38.86	52.57	74.67
DCF24-24N	1-1/2	38.10	1-1/2	34.03	2-3/8	60.33	2-1/4	57.15	50.03	45.21	56.13	83.81
DCF32-32N	2	50.80	2	45.97	2-1/8	73.03	3	76.20	67.56	62.73	64.26	101.60

Female Connector
DCF-N

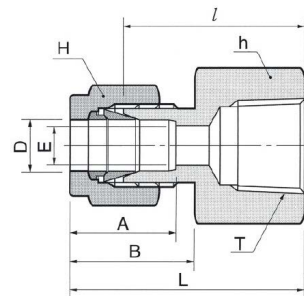

Connects metric tube to male NPT thread

Part No.	Tube O.D. D	T NPT	E Min.	Width across flat		A	B	ℓ	L
				h	H				
DCF3M-2N	3	1/8	2.4	14	12	12.9	15.3	22.1	28.7
DCF3M-4N	3	1/4	2.4	19	12	12.9	15.3	26.9	33.5
DCF4M-2N	4	1/8	2.4	14	12	13.7	16.1	23.1	29.7
DCF6M-2N	6	1/8	4.8	14	14	15.3	17.7	23.9	31.3
DCF6M-4N	6	1/4	4.8	19	14	15.3	17.7	28.4	35.8
DCF6M-6N	6	3/8	4.8	22	14	15.3	17.7	29.5	36.9
DCF6M-8N	6	1/2	4.8	27	14	15.3	17.7	35.1	42.5
DCF8M-2N	8	1/8	6.4	15	16	16.2	18.6	24.6	32.1
DCF8M-4N	8	1/4	6.4	19	16	16.2	18.6	29.5	37.0
DCF8M-6N	8	3/8	6.4	22	16	16.2	18.6	30.2	37.7
DCF8M-8N	8	1/2	6.4	27	16	16.2	18.6	35.8	43.3
DCF10M-2N	10	1/8	7.9	18	19	17.2	19.5	25.4	33.0
DCF10M-4N	10	1/4	7.9	19	19	17.2	19.5	30.2	37.8
DCF10M-6N	10	3/8	7.9	22	19	17.2	19.5	31.0	38.6
DCF10M-8N	10	1/2	7.9	27	19	17.2	19.5	36.6	44.2
DCF12M-2N	12	1/8	8.3	22	22	22.8	22.0	28.4	38.5
DCF12M-4N	12	1/4	9.5	22	22	22.8	22.0	30.2	40.3
DCF12M-6N	12	3/8	9.5	22	22	22.8	22.0	31.0	41.1
DCF12M-8N	12	1/2	9.5	27	22	22.8	22.0	36.6	46.7
DCF12M-12N	12	3/4	9.5	35	22	22.8	22.0	38.9	49.0
DCF15M-8N	15	1/2	11.9	27	25	24.4	22.0	36.6	46.7
DCF16M-8N	16	1/2	12.7	27	25	24.4	22.0	36.8	46.9
DCF20M-8N	20	1/2	15.9	30	32	26.0	22.0	37.8	47.9
DCF20M-12N	20	3/4	15.9	35	32	26.0	22.0	39.6	49.7
DCF22M-12N	22	3/4	18.3	35	32	26.0	22.0	39.6	49.7
DCF22M-16N	22	1	18.3	41	32	26.0	22.0	47.8	57.9
DCF25M-12N	25	3/4	21.8	35	38	31.3	26.5	41.1	53.4
DCF25M-16N	25	1	21.8	41	38	31.3	26.5	50.0	62.3

Female Connector

DCF-R

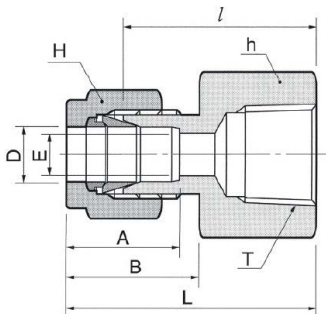

Connects fractional tube to male ISO tapered thread

Part No.	Tube O.D. D		T PT	E Min.	Width across flat				A	B	ℓ	L
	in.	mm			h		H					
DCF2-2R	1/8	3.17	1/8	2.28	9/16	14.28	7/16	11.11	12.70	15.24	22.09	28.70
DCF4-2R	1/4	6.35	1/8	4.82	9/16	14.28	9/16	14.28	15.24	17.78	23.87	31.24
DCF4-4R	1/4	6.35	1/4	4.82	3/4	19.05	9/16	14.28	15.24	17.78	28.44	35.81
DCF4-6R	1/4	6.35	3/8	4.82	7/8	22.22	9/16	14.28	15.24	17.78	30.22	37.59
DCF4-8R	1/4	6.35	1/2	4.82	1-1/16	26.98	9/16	14.28	15.24	17.78	35.05	42.41
DCF6-4R	3/8	9.52	1/4	7.11	3/4	19.05	11/16	17.46	16.76	19.30	30.22	37.59
DCF6-6R	3/8	9.52	3/8	7.11	7/8	22.22	11/16	17.46	16.76	19.30	31.75	39.11
DCF6-8R	3/8	9.52	1/2	7.11	1-1/16	26.98	11/16	17.46	16.76	19.30	36.57	43.94
DCF8-2R	1/2	12.70	1/8	10.41	13/16	20.64	7/8	22.22	22.86	21.84	25.40	35.56
DCF8-4R	1/2	12.70	1/4	10.41	1-3/16	20.64	7/8	22.22	22.86	21.84	30.22	40.38
DCF8-6R	1/2	12.70	3/8	10.41	7/8	22.22	7/8	22.22	22.86	21.84	31.75	41.91
DCF8-8R	1/2	12.70	1/2	10.41	1-1/16	26.98	7/8	22.22	22.86	21.84	36.57	46.73
DCF8-12R	1/2	12.70	3/4	10.41	1-5/16	33.33	7/8	22.22	22.86	21.84	38.10	48.26
DCF10-6R	5/8	15.87	3/8	12.70	15/16	23.81	1	25.40	24.38	21.84	31.75	41.91
DCF10-8R	5/8	15.87	1/2	12.70	1-1/16	26.98	1	25.40	24.38	21.84	36.57	46.73
DCF10-12R	5/8	15.87	3/4	12.70	1-5/16	33.33	1	25.40	24.38	21.84	38.10	48.26
DCF12-8R	3/4	19.05	1/2	15.74	1-1/16	26.98	1-1/8	28.58	24.38	21.84	36.57	46.73
DCF12-12R	3/4	19.05	3/4	15.74	1-5/16	33.33	1-1/8	28.58	24.38	21.84	38.10	48.26
DCF16-12R	1	25.40	3/4	22.35	1-3/8	34.92	1-1/2	38.10	31.24	26.41	41.14	53.34
DCF16-16R	1	25.40	1	22.35	1-5/8	41.27	1-1/2	38.10	31.24	26.41	50.03	62.23
DCF20-16R	1-1/4	31.75	1	27.68	1-3/4	44.45	1-7/8	47.63	41.14	38.86	52.57	74.67
DCF20-20R	1-1/4	31.75	1-1/4	27.68	2-1/8	53.98	1-7/8	47.63	41.14	38.86	52.57	74.67
DCF24-24R	1-1/2	38.10	1-1/2	34.03	2-3/8	60.33	2-1/4	57.15	50.03	45.21	56.13	83.81

Connects metric tube to male ISO tapered thread

Part No.	Tube O.D. D	T PT	E Min.	Width across flat		A	B	ℓ	L
				h	H				
DCF3M-2R	3	1/8	2.4	14	12	12.9	15.3	22.1	28.7
DCF3M-4R	3	1/4	2.4	19	12	12.9	15.3	26.9	33.5
DCF4M-2R	4	1/8	2.4	14	12	13.7	16.1	23.1	29.7
DCF6M-2R	6	1/8	4.8	14	14	15.3	17.7	23.9	31.3
DCF6M-4R	6	1/4	4.8	19	14	15.3	17.7	28.4	35.8
DCF6M-6R	6	3/8	4.8	22	14	15.3	17.7	29.5	36.9
DCF6M-8R	6	1/2	4.8	27	14	15.3	17.7	35.1	42.5
DCF8M-2R	8	1/8	6.4	15	16	16.2	18.6	24.6	32.1
DCF8M-4R	8	1/4	6.4	19	16	16.2	18.6	29.5	37.0
DCF8M-6R	8	3/8	6.4	22	16	16.2	18.6	30.2	37.7
DCF8M-8R	8	1/2	6.4	27	16	16.2	18.6	35.8	43.3
DCF10M-2R	10	1/8	7.9	18	19	17.2	19.5	25.4	33.0
DCF10M-4R	10	1/4	7.9	19	19	17.2	19.5	30.2	37.8
DCF10M-6R	10	3/8	7.9	22	19	17.2	19.5	31.0	38.6
DCF10M-8R	10	1/2	7.9	27	19	17.2	19.5	36.6	44.2
DCF12M-2R	12	1/8	8.3	22	22	22.8	22.0	28.4	38.5
DCF12M-4R	12	1/4	9.5	22	22	22.8	22.0	30.2	40.3
DCF12M-6R	12	3/8	9.5	22	22	22.8	22.0	31.0	41.1
DCF12M-8R	12	1/2	9.5	27	22	22.8	22.0	36.6	46.7
DCF12M-12R	12	3/4	9.5	35	22	22.8	22.0	38.9	49.0
DCF15M-8R	15	1/2	11.9	27	25	24.4	22.0	36.6	46.7
DCF16M-8R	16	1/2	12.7	27	25	24.4	22.0	36.8	46.9
DCF20M-8R	20	1/2	15.9	30	32	26.0	22.0	37.8	47.9
DCF20M-12R	20	3/4	15.9	35	32	26.0	22.0	39.6	49.7
DCF22M-8R	22	1/2	18.3	30	32	26.0	22.0	38.0	48.1
DCF22M-12R	22	3/4	18.3	35	32	26.0	22.0	39.6	49.7
DCF22M-16R	22	1	18.3	41	32	26.0	22.0	47.8	57.9
DCF25M-8R	25	1/2	21.8	35	38	31.3	26.5	41.1	53.4
DCF25M-12R	25	3/4	21.8	35	38	31.3	26.5	41.1	53.4
DCF25M-16R	25	1	21.8	41	38	31.3	26.5	50.0	62.3

Gauge Connector (Previously DCG)

DCF-GG

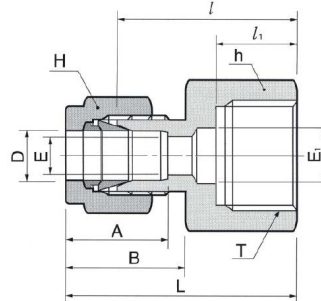
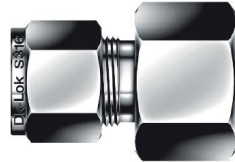

Connects fractional tube to Gauge (Male ISO parallel thread)

Part No.	Tube O.D. D		T PF	E Min.	E1	Width across flat				A	B	ℓ	ℓ1	L
	in.	mm				h		H						
						in.	mm	in.	mm					
DCF2-4GG	1/8	3.17	1/4	2.4	5.5	3/4	19.05	7/16	11.11	12.70	15.24	28.70	13.00	35.31
DCF4-2GG	1/4	6.35	1/8	4.82	-	9/16	14.28	9/16	14.28	15.24	17.78	26.30	12.00	33.55
DCF4-4GG	1/4	6.35	1/4	4.82	5.5	3/4	19.05	9/16	14.28	15.24	17.78	30.22	13.00	37.59
DCF4-6GG	1/4	6.35	3/8	4.82	6.5	15/16	23.81	9/16	14.28	15.24	17.78	30.22	14.22	37.59
DCF4-8GG	1/4	6.35	1/2	4.82	7.0	1-1/16	26.98	9/16	14.28	15.24	17.78	30.07	18.80	43.43
DCF5-4GG	5/16	7.93	1/4	5.58	5.5	3/4	19.05	5/8	15.87	16.25	18.54	30.98	13.00	38.35
DCF5-8GG	5/16	7.93	1/2	7.11	7.0	1-1/16	26.98	5/8	15.87	16.25	18.54	33.02	18.80	40.38
DCF6-4GG	3/8	9.52	1/4	5.58	5.5	3/4	19.05	11/16	17.46	16.76	19.30	31.75	12.95	39.12
DCF6-6GG	3/8	9.52	3/8	6.60	6.5	15/16	23.81	11/16	17.46	16.76	19.30	31.24	14.22	38.61
DCF6-8GG	3/8	9.52	1/2	7.11	7.0	1-1/16	26.98	11/16	17.46	16.76	19.30	34.54	18.80	41.91
DCF8-4GG	1/2	12.70	1/4	5.50	5.5	7/8	22.22	7/8	22.22	22.86	21.84	31.80	13.00	41.95
DCF8-6GG	1/2	12.70	3/8	6.60	6.5	15/16	23.81	7/8	22.22	22.86	21.84	34.29	14.24	44.45
DCF8-8GG	1/2	12.70	1/2	7.11	7.0	1-1/16	26.98	7/8	22.22	22.86	21.84	38.10	18.80	48.26

Connects Metric tube to Gauge (Male ISO parallel thread)

Part No.	Tube O.D. D	T PF	E Min.	E1	Width across flat		A	B	ℓ	ℓ1	L
					h	H					
DCF3M-4GG	3	1/4	2.4	5.5	19	12	12.9	15.3	28.7	13	35.3
DCF6M-4GG	6	1/4	4.8	5.5	19	14	15.3	17.7	30.2	13	37.6
DCF6M-6GG	6	3/8	4.8	6.5	24	14	15.3	17.7	30.2	14	37.6
DCF6M-8GG	6	1/2	4.8	7.0	27	14	15.3	17.7	36.3	19	43.0
DCF8M-4GG	8	1/4	5.5	5.5	19	16	16.2	18.6	31.0	13	38.5
DCF8M-6GG	8	3/8	6.5	6.5	24	16	16.2	18.6	28.7	14	36.2
DCF8M-8GG	8	1/2	7.0	7.0	27	16	16.2	18.6	33.0	19	40.5
DCF10M-4GG	10	1/4	5.5	5.5	19	19	17.2	19.5	31.8	13	39.4
DCF10M-6GG	10	3/8	6.5	6.5	24	19	17.2	19.5	31.2	14	38.8
DCF10M-8GG	10	1/2	7.0	7.0	27	19	17.2	19.5	33.8	19	41.4
DCF12M-4GG	12	1/4	5.5	5.5	22	22	22.8	22.0	31.8	13	41.9
DCF12M-6GG	12	3/8	6.5	6.5	24	22	22.8	22.0	34.3	14	44.4
DCF12M-8GG	12	1/2	7.0	7.0	27	22	22.8	22.0	38.1	19	48.2
DCF20M-8GG	20	1/2	7.0	7.0	30	32	26.0	22.0	44.2	19	54.3
DCF22M-8GG	22	1/2	7.0	7.0	30	32	26.0	22.0	44.2	19	54.3

Bulkhead Female Connector
DCBF-N

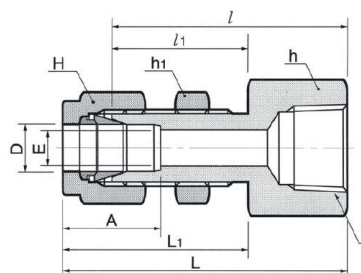

Connects fractional tube to male NPT thread

Part No.	Tube O.D. D		T NPT	E Min.	Width across flat						A	ℓ	ℓ1	L	L1	Panel Hole Drill size	Panel Max Thickness
	in.	mm			h		h1		H								
					in.	mm	in.	mm	in.	mm							
DCBF2-2N	1/8	3.17	1/8	2.28	9/16	14.28	1/2	12.70	7/16	11.11	12.70	38.10	24.63	44.70	31.24	8.33	12.70
DCBF4-2N	1/4	6.35	1/8	4.82	5/8	15.87	5/8	15.87	9/16	14.28	15.24	39.62	26.16	46.99	33.52	11.50	10.16
DCBF4-4N	1/4	6.35	1/4	4.82	3/4	19.05	5/8	15.87	9/16	14.28	15.24	44.45	26.16	51.81	33.52	11.50	10.16
DCBF6-4N	3/8	9.52	1/4	7.11	3/4	19.05	3/4	19.05	11/16	17.46	16.76	47.75	29.46	55.11	36.83	14.68	11.17
DCBF6-6N	3/8	9.52	3/8	7.11	7/8	22.22	3/4	19.05	11/16	17.46	16.76	49.41	29.46	56.77	36.83	14.68	11.17
DCBF8-6N	1/2	12.70	3/8	10.41	15/16	23.81	15/16	23.81	7/8	22.22	22.86	51.56	31.75	61.72	41.91	19.44	12.70
DCBF8-8N	1/2	12.70	1/2	10.41	1-1/16	26.98	15/16	23.81	7/8	22.22	22.86	56.38	31.75	66.54	41.91	19.44	12.70
DCBF12-12N	3/4	19.05	3/4	15.74	1-1/4	31.75	1-3/16	30.16	1-1/8	28.57	24.38	63.60	38.30	73.51	47.21	25.79	16.76
DCBF16-16N	1	25.40	1	22.35	1-5/8	41.27	1-5/8	41.27	1-1/2	38.10	31.24	81.04	45.21	93.23	57.40	33.73	19.05
DCBF20-20N	1-1/4	31.75	1-1/4	27.68	1-7/8	47.63	1-7/8	47.63	1-7/8	47.63	41.14	83.49	47.75	105.59	69.85	41.67	19.05
DCBF24-24N	1-1/2	38.10	1-1/2	33.90	1-1/4	57.15	2-1/4	57.15	2-1/4	57.15	50.03	87.39	49.27	114.57	76.45	49.61	19.05
DCBF32-32N	2	50.80	2	45.97	1-3/4	69.85	2-3/4	69.85	3	76.20	67.56	95.30	56.38	132.63	93.71	57.94	19.05

Connects metric tube to male NPT thread

Part No.	Tube O.D. D	T NPT	E Min.	Width across flat			A	ℓ	ℓ1	L	L1	Panel Hole Drill size	Panel Max Thickness
				h	h1	H							
DCBF6M-2N	6	1/8	4.8	15.8	15.8	14	15.3	39.6	26.2	46.90	35.00	11.5	10.2
DCBF6M-4N	6	1/4	4.8	19.0	16.0	14	15.3	44.4	26.2	51.80	33.60	11.5	10.2
DCBF8M-4N	8	1/4	6.3	19.0	17.4	16	16.2	46.7	28.6	53.85	35.55	13.1	11.2
DCBF12M-8N	12	1/2	9.5	27.0	24.0	22	22.8	56.4	31.8	66.50	41.90	19.5	12.7

Female Elbow
DLF-N

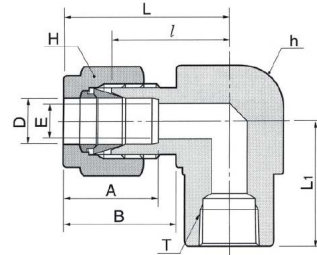

Connects fractional tube to male NPT thread

Part No.	Tube O.D. D		T NPT	E Min.	Width across flat				A	B	ℓ	L	L1
	in.	mm			h		H						
					in.	mm	in.	mm					
DLF2-2N	1/8	3.17	1/8	2.28	1/2	12.70	7/16	11.11	12.70	15.24	18.03	24.63	19.05
DLF2-4N	1/8	3.17	1/4	2.28	11/16	17.46	7/16	11.11	12.70	15.24	20.82	27.43	22.35
DLF3-2N	3/16	4.76	1/8	3.04	1/2	12.70	1/2	12.70	13.71	16.00	18.79	25.40	19.05
DLF4-2N	1/4	6.35	1/8	4.82	1/2	12.70	9/16	14.28	15.24	17.78	19.55	26.92	19.05
DLF4-4N	1/4	6.35	1/4	4.82	11/16	17.46	9/16	14.28	15.24	17.78	22.35	29.71	22.35
DLF4-6N	1/4	6.35	3/8	4.82	13/16	20.64	9/16	14.28	15.24	17.78	24.38	31.75	22.35
DLF4-8N	1/4	6.35	1/2	4.82	1	25.40	9/16	14.28	15.24	17.78	27.17	34.54	28.44
DLF5-2N	5/16	7.93	1/8	6.35	9/16	14.28	5/8	15.87	16.25	18.54	21.33	28.70	19.05
DLF5-4N	5/16	7.93	1/4	6.35	11/16	17.46	5/8	15.87	16.25	18.54	23.11	30.48	22.35
DLF6-2N	3/8	9.52	1/8	7.11	5/8	15.87	11/16	17.46	16.76	19.30	23.11	30.48	19.05
DLF6-4N	3/8	9.52	1/4	7.11	11/16	17.46	11/16	17.46	16.76	19.30	23.87	31.24	22.35
DLF6-6N	3/8	9.52	3/8	7.11	13/16	20.64	11/16	17.46	16.76	19.30	25.90	33.27	22.35
DLF6-8N	3/8	9.52	1/2	7.11	1	25.40	11/16	17.46	16.76	19.30	28.70	36.06	28.44
DLF8-4N	1/2	12.70	1/4	10.41	13/16	20.64	7/8	22.22	22.86	21.84	25.90	36.06	22.35
DLF8-6N	1/2	12.70	3/8	10.41	13/16	20.64	7/8	22.22	22.86	21.84	25.90	36.06	22.35
DLF8-8N	1/2	12.70	1/2	10.41	1	25.40	7/8	22.22	22.86	21.84	28.70	38.86	28.44
DLF10-6N	5/8	15.87	3/8	12.70	15/16	23.81	1	25.40	24.38	21.84	27.94	38.10	22.35
DLF10-8N	5/8	15.87	1/2	12.70	1	25.40	1	25.40	24.38	21.84	29.71	39.87	28.44
DLF12-8N	3/4	19.05	1/2	15.74	1-1/16	26.98	1-1/8	28.58	24.38	21.84	29.71	39.87	28.44
DLF12-12N	3/4	19.05	3/4	15.74	1-3/8	34.92	1-1/8	28.58	24.38	21.84	34.54	44.70	31.75
DLF14-12N	7/8	22.22	3/4	18.28	1-3/8	34.92	1-1/4	31.75	25.90	21.84	34.54	44.70	31.75
DLF16-12N	1	25.40	3/4	22.35	1-3/8	34.92	1-1/2	38.10	31.24	26.41	36.83	49.02	31.75
DLF16-16N	1	25.40	1	22.35	1-11/16	42.86	1-1/2	38.10	31.24	26.41	41.40	50.29	38.10

Connects metric tube to male NPT thread

Part No.	Tube O.D. D	T NPT	E Min.	Width across flat		A	B	ℓ	L	L1
				h	H					
DLF6M-2N	6	1/8	4.8	12.70	14	15.3	17.7	19.6	27.0	19.00
DLF6M-4N	6	1/4	4.8	17.46	14	15.3	17.7	22.4	29.8	22.40
DLF6M-6N	6	3/8	4.8	20.64	14	15.3	17.7	24.4	31.7	22.40
DLF6M-8N	6	1/2	4.8	25.40	14	15.3	17.7	27.2	34.6	28.40
DLF8M-2N	8	1/8	6.4	15.87	16	16.2	18.6	23.1	29.9	19.00
DLF8M-4N	8	1/4	6.4	17.46	16	16.2	18.6	23.1	30.6	22.40
DLF8M-8N	8	1/2	6.4	25.40	16	16.2	18.6	28.0	35.2	28.40
DLF10M-2N	10	1/8	7.9	17.46	19	17.2	19.5	23.9	31.5	19.00
DLF10M-4N	10	1/4	7.9	17.46	19	17.2	19.5	25.9	33.5	22.35
DLF10M-6N	10	3/8	7.9	20.64	19	17.2	19.5	25.9	33.5	22.40
DLF10M-8N	10	1/2	7.9	25.40	19	17.2	19.5	28.7	36.1	28.40
DLF12M-4N	12	1/4	9.5	20.64	22	22.8	22.0	25.9	36.0	22.40
DLF12M-6N	12	3/8	9.5	20.64	22	22.8	22.0	25.9	36.2	22.35
DLF12M-8N	12	1/2	9.5	25.40	22	22.8	22.0	28.7	38.8	28.40
DLF16M-8N	16	1/2	12.7	26.98	25	24.4	22.0	29.7	39.5	28.40

Female Run Tee
DTBF-N

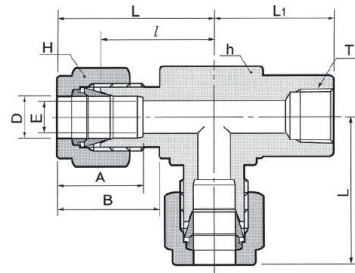

Connects fractional tube to male NPT thread

Part No.	Tube O.D. D		T NPT	E Min.	Width across flat				A	B	ℓ	L	L1
	in.	mm			h		H						
DTRF2-2N	1/8	3.17	1/8	2.28	1/2	12.70	7/16	11.11	12.70	15.24	18.03	24.63	19.05
DTRF2-4N	1/8	3.17	1/4	2.28	11/16	17.46	7/16	11.11	12.70	15.24	20.82	27.43	22.35
DTRF3-2N	3/16	4.76	1/8	3.04	1/2	12.70	1/2	12.70	13.71	16.00	18.79	25.40	19.05
DTRF4-2N	1/4	6.35	1/8	4.82	1/2	12.70	9/16	14.28	15.24	17.78	19.55	26.92	19.05
DTRF4-4N	1/4	6.35	1/4	4.82	11/16	17.46	9/16	14.28	15.24	17.78	22.86	29.71	22.35
DTRF4-6N	1/4	6.35	3/8	4.82	13/16	20.64	9/16	14.28	15.24	17.78	24.38	31.75	22.35
DTRF4-8N	1/4	6.35	1/2	4.82	1	25.40	9/16	14.28	15.24	17.78	27.17	34.54	28.44
DTRF5-2N	5/16	7.94	1/8	6.35	9/16	14.28	5/8	15.87	16.25	18.54	21.33	28.70	19.05
DTRF5-4N	5/16	7.94	1/4	6.35	11/16	17.46	5/8	15.87	16.25	18.54	23.11	30.48	22.35
DTRF6-2N	3/8	9.52	1/8	7.11	5/8	15.87	11/16	17.46	16.76	19.30	23.11	30.48	19.05
DTRF6-4N	3/8	9.52	1/4	7.11	11/16	17.46	11/16	17.46	16.76	19.30	23.87	31.24	22.35
DTRF6-6N	3/8	9.52	3/8	6.35	13/16	20.64	11/16	17.46	16.76	19.30	25.90	33.27	22.35
DTRF6-8N	3/8	9.52	1/2	7.11	1	25.40	11/16	17.46	16.76	19.30	28.70	36.06	28.44
DTRF8-4N	1/2	12.70	1/4	10.41	13/16	20.64	7/8	22.22	22.86	21.84	25.90	36.06	22.35
DTRF8-6N	1/2	12.70	3/8	10.41	13/16	20.64	7/8	22.22	22.86	21.84	25.90	36.06	22.35
DTRF8-8N	1/2	12.70	1/2	10.41	1	25.40	7/8	22.22	22.86	21.84	29.71	39.87	28.44
DTRF10-6N	5/8	15.87	3/8	12.70	15/16	23.81	1	25.40	24.38	21.84	27.94	38.10	22.35
DTRF10-8N	5/8	15.87	1/2	12.70	1	25.40	1	25.40	24.38	21.84	28.70	38.86	28.44
DTRF12-8N	3/4	19.05	1/2	15.74	1-1/16	26.98	1-1/8	28.58	24.38	21.84	29.71	39.87	28.44
DTRF12-12N	3/4	19.05	3/4	15.74	1-3/8	34.92	1-1/8	28.58	24.38	21.84	34.54	44.70	31.75
DTRF14-12N	7/8	22.22	3/4	18.28	1-3/8	34.92	1-1/4	31.75	31.75	21.84	34.54	44.70	31.75
DTRF16-12N	1	25.40	3/4	22.35	1-3/8	34.92	1-1/2	38.10	38.10	26.41	36.83	49.02	31.75
DTRF16-16N	1	25.40	1	22.35	1-1/16	42.86	1-1/2	38.10	38.10	26.41	41.40	50.29	38.10

Connects metric tube to male NPT thread

Part No.	Tube O.D. D	T NPT	E Min.	Width across flat		A	B	ℓ	L	L1
				h	H					
DTRF6M-2N	6	1/8	4.8	12.70	14	15.3	17.7	19.6	27.0	19.00
DTRF6M-4N	6	1/4	4.8	17.46	14	15.3	17.7	22.4	29.8	22.40
DTRF6M-6N	6	3/8	4.8	20.64	14	15.3	17.7	24.4	31.7	22.40
DTRF6M-8N	6	1/2	4.8	25.40	14	15.3	17.7	27.2	34.5	28.40
DTRF8M-2N	8	1/8	6.4	15.87	16	16.2	18.6	23.1	29.9	19.00
DTRF8M-4N	8	1/4	6.4	17.46	16	16.2	18.6	23.1	30.6	22.40
DTRF8M-6N	8	3/8	6.4	20.64	16	16.2	18.6	25.2	32.4	22.40
DTRF8M-8N	8	1/2	6.4	25.40	16	16.2	18.6	28.0	35.2	28.40
DTRF10M-2N	10	1/8	7.9	20.64	19	17.2	19.5	23.9	31.5	19.00
DTRF10M-4N	10	1/4	7.9	20.64	19	17.2	19.5	25.9	33.6	22.40
DTRF10M-6N	10	3/8	7.9	20.64	19	17.2	19.5	25.9	33.6	22.40
DTRF10M-8N	10	1/2	7.9	25.40	19	17.2	19.5	26.2	33.6	28.40
DTRF12M-4N	12	1/4	9.5	20.64	22	22.8	22.0	25.9	36.0	22.40
DTRF12M-6N	12	3/8	9.5	20.64	22	22.8	22.0	25.9	36.0	22.40
DTRF12M-8N	12	1/2	9.5	25.40	22	22.8	22.0	29.7	40.0	28.40
DTRF16M-8N	16	1/2	12.7	25.40	25	24.4	22.0	29.7	40.0	28.40

Female Branch Tee DTBF-N

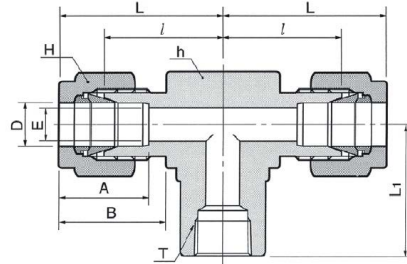

Connects fractional tube to male NPT thread

Part No.	Tube O.D. D		T NPT	E Min.	Width across flat				A	B	ℓ	L	L1
	in.	mm			h		H						
DTBF2-2N	1/8	3.17	1/8	2.28	1/2	12.70	7/16	11.11	12.70	15.24	18.03	24.38	19.05
DTBF2-4N	1/8	3.17	1/4	2.28	11/16	17.46	7/16	11.11	12.70	15.24	20.82	27.43	22.35
DTBF3-2N	3/16	4.76	1/8	3.04	1/2	12.70	1/2	12.70	13.71	16.00	18.79	25.40	19.05
DTBF4-2N	1/4	6.35	1/8	4.82	1/2	12.70	9/16	14.28	15.24	17.78	19.55	26.92	19.05
DTBF4-4N	1/4	6.35	1/4	4.82	11/16	17.46	9/16	14.28	15.24	17.78	22.35	29.71	22.35
DTBF4-6N	1/4	6.35	3/8	4.82	13/16	20.64	9/16	14.28	15.24	17.78	24.38	31.75	22.35
DTBF4-8N	1/4	6.35	1/2	4.82	1	25.40	9/16	14.28	15.24	17.78	27.17	34.54	28.44
DTBF5-2N	5/16	7.94	1/8	6.35	9/16	14.28	5/8	15.87	16.25	18.54	21.33	28.70	19.05
DTBF5-4N	5/16	7.94	1/4	6.35	11/16	17.46	5/8	15.87	16.25	18.54	23.11	30.48	22.35
DTBF6-2N	3/8	9.52	1/8	7.11	5/8	15.87	11/16	17.46	16.76	19.30	23.11	30.48	19.05
DTBF6-4N	3/8	9.52	1/4	7.11	11/16	17.46	11/16	17.46	16.76	19.30	23.87	31.24	22.35
DTBF6-6N	3/8	9.52	3/8	6.35	13/16	20.64	11/16	17.46	16.76	19.30	25.90	33.27	22.35
DTBF6-8N	3/8	9.52	1/2	7.11	1	25.40	11/16	17.46	16.76	19.30	28.70	36.06	28.44
DTBF8-4N	1/2	12.70	1/4	10.41	13/16	20.64	7/8	22.22	22.86	21.84	25.90	36.06	22.35
DTBF8-6N	1/2	12.70	3/8	10.41	13/16	20.64	7/8	22.22	22.86	21.84	25.90	36.06	22.35
DTBF8-8N	1/2	12.70	1/2	10.41	1	25.40	7/8	22.22	22.86	21.84	29.71	39.87	28.44
DTBF10-6N	5/8	15.87	3/8	12.70	15/16	23.81	1	25.40	24.38	21.84	27.94	38.10	22.35
DTBF10-8N	5/8	15.87	1/2	12.70	1	25.40	1	25.40	24.38	21.84	28.70	38.86	28.44
DTBF12-8N	3/4	19.05	1/2	15.74	1-1/16	26.98	1-1/8	28.58	24.38	21.84	29.71	39.87	28.44
DTBF12-12N	3/4	19.05	3/4	15.74	1-3/8	34.92	1-1/8	28.58	24.38	21.84	34.54	44.70	31.75
DTBF14-12N	7/8	22.22	3/4	18.28	1-3/8	34.92	1-1/4	31.75	25.90	21.84	34.54	44.70	31.75
DTBF16-12N	1	25.40	3/4	22.35	1-3/8	34.92	1-1/2	38.10	31.24	26.41	36.83	49.02	31.75
DTBF16-16N	1	25.40	1	22.35	1-11/16	42.86	1-1/2	38.10	31.24	26.41	41.40	53.59	38.10

Connects metric tube to male NPT thread

Part No.	Tube O.D. D	T NPT	E Min.	Width across flat		A	B	ℓ	L	L1
				h	H					
DTBF6M-2N	6	1/8	4.8	12.70	14	15.3	17.7	19.6	27.0	19.00
DTBF6M-4N	6	1/4	4.8	17.46	14	15.3	17.7	22.4	29.8	22.40
DTBF6M-6N	6	3/8	4.8	20.64	14	15.3	17.7	24.4	31.7	22.40
DTBF6M-8N	6	1/2	4.8	25.40	14	15.3	17.7	27.2	34.5	28.40
DTBF8M-2N	8	1/8	6.4	15.87	16	16.2	18.6	23.1	29.9	19.00
DTBF8M-4N	8	1/4	6.4	17.46	16	16.2	18.6	23.1	30.6	22.40
DTBF8M-6N	8	3/8	6.4	20.64	16	16.2	18.6	25.2	32.4	22.40
DTBF8M-8N	8	1/2	6.4	25.40	16	16.2	18.6	28.0	35.2	28.40
DTBF10M-2N	10	1/8	7.9	17.50	19	17.2	19.5	23.9	31.5	19.00
DTBF10M-4N	10	1/4	7.9	20.64	19	17.2	19.5	25.9	33.5	22.40
DTBF10M-6N	10	3/8	7.9	20.64	19	17.2	19.5	25.9	33.5	22.40
DTBF10M-8N	10	1/2	9.5	25.40	19	17.2	19.5	26.2	33.6	22.40
DTBF12M-4N	12	1/4	9.5	20.64	22	22.8	22.0	25.9	36.0	22.40
DTBF12M-6N	12	3/8	9.5	20.64	22	22.8	22.0	25.9	36.0	22.40
DTBF12M-8N	12	1/2	9.5	25.40	22	22.8	22.0	29.7	40.0	28.70
DTBF16M-8N	16	1/2	12.7	25.40	25	24.4	22.0	29.7	40.0	28.70

Reducer
DR

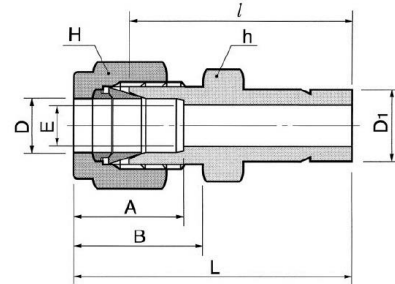
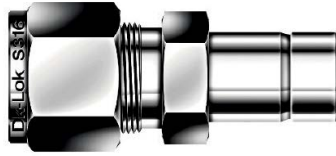

Connects fractional tube to fractional DK-Lok port

Part No.	Tube O.D.				E Min.	Width across flat				A	B	ℓ	L
	D		D1			h		H					
	in.	mm	in.	mm		in.	mm	in.	mm				
DR1-2	1/16	1.59	1/8	3.17	1.27	5/16	7.93	5/16	7.93	8.63	10.92	25.40	29.21
DR1-4	1/16	1.59	1/4	6.35	1.27	5/16	7.93	5/16	7.93	8.63	10.92	27.68	31.49
DR2-1	1/8	3.17	1/16	1.59	1.76	7/16	11.11	7/16	11.11	12.70	15.24	22.35	28.95
DR2-2	1/8	3.17	1/8	3.17	2.03	7/16	11.11	7/16	11.11	12.70	15.24	26.92	33.52
DR2-3	1/8	3.17	3/16	4.76	2.28	7/16	11.11	7/16	11.11	12.70	15.24	27.68	34.29
DR2-4	1/8	3.17	1/4	6.35	2.28	7/16	11.11	7/16	11.11	12.70	15.24	29.46	36.06
DR2-6	1/8	3.17	3/8	9.52	2.28	7/16	11.11	7/16	11.11	12.70	15.24	30.98	37.59
DR2-8	1/8	3.17	1/2	12.70	2.28	9/16	14.28	7/16	11.11	12.70	15.24	37.59	44.19
DR3-2	3/16	4.76	1/8	3.17	2.03	7/16	11.11	1/2	12.70	13.71	16.00	28.19	34.79
DR3-4	3/16	4.76	1/4	6.35	3.04	7/16	11.11	1/2	12.70	13.71	16.00	30.48	37.08
DR4-2	1/4	6.35	1/8	3.17	2.03	1/2	12.70	9/16	14.28	15.24	17.78	29.46	36.83
DR4-3	1/4	6.35	3/16	4.76	3.04	1/2	12.70	9/16	14.28	15.24	17.78	30.22	37.59
DR4-4	1/4	6.35	1/4	6.35	4.82	1/2	12.70	9/16	14.28	15.24	17.78	31.75	39.11
DR4-5	1/4	6.35	5/16	7.93	4.82	1/2	12.70	9/16	14.28	15.24	17.78	32.51	39.87
DR4-6	1/4	6.35	3/8	9.52	4.82	1/2	12.70	9/16	14.28	15.24	17.78	33.27	40.64
DR4-8	1/4	6.35	1/2	12.70	4.82	9/16	14.28	9/16	14.28	15.24	17.78	38.86	46.22
DR4-10	1/4	6.35	5/8	15.87	4.82	11/16	17.46	9/16	14.28	15.24	17.78	40.64	48.00
DR4-12	1/4	6.35	3/4	19.05	4.82	13/16	20.64	9/16	14.28	15.24	17.78	40.38	47.75
DR5-6	5/16	7.93	3/8	9.52	6.35	9/16	14.28	5/8	15.87	16.25	18.54	34.54	41.91
DR5-8	5/16	7.93	1/2	12.70	6.35	9/16	14.28	5/8	15.87	16.25	18.54	40.13	47.49
DR6-4	3/8	9.52	1/4	6.35	4.82	5/8	15.87	11/16	17.46	16.76	19.30	34.03	41.40
DR6-6	3/8	9.52	3/8	9.52	7.11	5/8	15.87	11/16	17.46	16.76	19.30	35.81	43.18
DR6-8	3/8	9.52	1/2	12.70	7.11	5/8	15.87	11/16	17.46	16.76	19.30	41.14	45.81
DR6-10	3/8	9.52	5/8	15.87	7.11	11/16	17.46	11/16	17.46	16.76	19.30	42.92	50.29
DR6-12	3/8	9.52	3/4	19.05	7.11	13/16	20.64	11/16	17.46	16.76	19.30	42.92	50.29
DR8-4	1/2	12.70	1/4	6.35	4.82	13/16	20.64	7/8	22.22	22.86	21.84	34.79	44.95
DR8-6	1/2	12.70	3/8	9.52	7.11	13/16	20.64	7/8	22.22	22.86	21.84	36.57	46.73
DR8-8	1/2	12.70	1/2	12.70	9.90	13/16	20.64	7/8	22.22	22.86	21.84	42.16	52.32
DR8-10	1/2	12.70	5/8	15.87	10.41	13/16	20.64	7/8	22.22	22.86	21.84	43.68	53.84
DR8-12	1/2	12.70	3/4	19.05	10.41	13/16	20.64	7/8	22.22	22.86	21.84	43.68	53.84
DR8-16	1/2	12.70	1	25.40	10.41	1-1/16	26.98	7/8	22.22	22.86	21.84	50.03	60.19
DR10-12	5/8	15.87	3/4	19.05	12.70	15/16	23.81	1	25.40	24.38	21.84	44.45	54.61
DR10-14	5/8	15.87	7/8	22.22	12.70	15/16	23.81	1	25.40	24.38	21.84	45.97	56.13
DR10-16	5/8	15.87	1	25.40	12.70	1-1/16	26.98	1	25.40	24.38	21.84	50.80	60.96
DR12-8	3/4	19.05	1/2	12.70	9.90	1-1/16	26.98	1-1/8	28.57	24.38	21.84	44.45	54.61
DR12-16	3/4	19.05	1	25.40	15.74	1-1/16	26.98	1-1/8	28.57	24.38	21.84	52.32	62.48
DR16-20	1	25.40	1-1/4	31.75	22.35	1-3/8	34.93	1-1/2	38.10	31.24	26.41	68.32	80.51
DR16-24	1	25.40	1-1/2	38.10	22.35	1-5/8	41.28	1-1/2	38.10	31.24	26.41	76.96	89.15
DR16-32	1	25.40	2	50.80	22.35	2-1/8	53.98	1-1/2	38.10	31.24	26.41	100.33	112.52
DR20-24	1-1/4	31.75	1-1/2	38.10	27.68	1-7/8	47.63	1-7/8	57.15	41.14	38.86	82.04	104.14
DR20-32	1-1/4	31.75	2	50.80	27.68	1-7/8	47.63	1-7/8	76.20	41.14	38.86	103.12	125.22
DR24-32	1-1/2	38.10	2	50.80	34.03	2-1/4	57.15	2-1/4	76.20	50.03	45.21	104.14	131.31

Connects metric tube to fractional DK-Lok port

Part No.	Tube O.D.			E Min.	Width across flat		A	B	ℓ	L
	D	D1			h	H				
		in.	mm							
DR2M-2	2	1/8	3.17	1.7	12	12	12.9	15.3	26.9	33.5
DR3M-2	3	1/8	3.17	2.0	12	12	12.9	15.3	26.9	33.5
DR3M-4	3	1/4	6.35	2.4	12	12	12.9	15.3	29.5	36.1
DR4M-4	4	1/4	6.35	2.4	12	12	13.7	16.1	30.5	37.1
DR6M-2	6	1/8	3.18	2.0	14	14	15.3	17.7	29.5	36.9
DR6M-4	6	1/4	6.35	4.8	14	14	15.3	17.7	31.8	39.2
DR6M-5	6	5/16	7.93	4.8	14	14	15.3	17.7	32.5	39.9
DR6M-6	6	3/8	9.52	4.8	14	14	15.3	17.7	33.3	40.7
DR6M-8	6	1/2	12.70	4.8	14	14	15.3	17.7	38.9	46.3
DR8M-6	8	3/8	9.52	6.4	15	16	16.2	18.6	34.5	42.0
DR8M-8	8	1/2	12.70	6.4	15	16	16.2	18.6	40.1	47.6
DR10M-6	10	3/8	9.52	7.1	18	19	17.2	19.5	36.6	44.2
DR10M-8	10	1/2	12.70	7.9	18	19	17.2	19.5	42.2	49.8
DR12M-8	12	1/2	12.70	9.5	22	22	22.8	22.0	42.2	52.3
DR12M-12	12	3/4	19.05	9.5	22	22	22.8	22.0	43.7	53.8
DR18M-12	18	3/4	19.05	15.1	27	30	24.4	22.0	46.0	56.1
DR18M-16	18	1	25.40	15.1	27	30	24.4	22.0	52.3	62.4
DR25M-16	25	1	25.40	20.2	35	38	31.3	26.5	57.2	69.5

Connects metric tube to metric DK-Lok port

Part No.	Tube O.D.		E Min.	Width across flat		A	B	ℓ	L
	D	D1		h	H				
DR2M-3M	2	3	1.7	12	12	12.9	15.3	26.9	35.3
DR3M-4M	3	4	2.4	12	12	12.9	15.3	28.4	35.0
DR3M-6M	3	6	2.4	12	12	12.9	15.3	29.5	36.1
DR3M-10M	3	10	2.4	12	12	12.9	15.3	31.8	38.4
DR4M-6M	4	6	2.4	12	12	13.7	16.1	30.5	37.1
DR6M-3M	6	3	1.8	14	14	15.3	17.7	29.5	36.9
DR6M-8M	6	8	4.8	14	14	15.3	17.7	32.5	39.9
DR6M-10M	6	10	4.8	14	14	15.3	17.7	33.3	40.7
DR6M-12M	6	12	4.8	14	14	15.3	17.7	38.9	46.3
DR8M-6M	8	6	4.6	15	16	16.2	18.6	32.8	40.3
DR8M-10M	8	10	6.4	15	16	16.2	18.6	34.5	42.0
DR8M-12M	8	12	6.4	15	16	16.2	18.6	40.1	47.6
DR10M-6M	10	6	4.6	18	19	17.2	19.5	34.8	42.4
DR10M-12M	10	12	7.9	18	19	17.2	19.5	42.2	49.8
DR10M-15M	10	15	7.9	18	19	17.2	19.5	43.7	51.3
DR10M-18M	10	18	7.9	19	19	17.2	19.5	43.7	51.3
DR12M-6M	12	6	4.6	22	22	22.8	22.0	34.8	44.9
DR12M-10M	12	10	7.7	22	22	22.8	22.0	36.6	46.7
DR12M-16M	12	16	9.5	22	22	22.8	22.0	43.7	53.8
DR12M-18M	12	18	9.5	22	22	22.8	22.0	43.7	53.8
DR12M-20M	12	20	9.5	22	22	22.8	22.0	46.0	56.1
DR12M-22M	12	22	9.5	24	22	22.8	22.0	46.0	56.1
DR12M-25M	12	25	9.5	27	22	22.8	22.0	52.3	62.4
DR16M-12M	16	12	9.1	24	25	24.4	22.0	42.9	53.0
DR18M-12M	18	12	9.1	27	30	24.4	22.0	44.5	54.6
DR18M-16M	18	16	12.7	27	30	24.4	22.0	46.0	56.1
DR18M-20M	18	20	15.1	27	30	24.4	22.0	47.5	57.6
DR18M-22M	18	22	15.1	27	30	24.4	22.0	47.5	57.6
DR18M-25M	18	25	15.1	27	30	24.4	22.0	52.3	62.4
DR20M-16M	20	16	12.7	30	32	26.0	22.0	47.8	57.9
DR20M-18M	20	18	13.9	30	32	26.0	22.0	47.8	57.9
DR20M-22M	20	22	15.8	30	32	26.0	22.0	49.3	59.4
DR20M-25M	20	25	15.8	30	32	26.0	22.0	54.1	64.2
DR22M-18M	22	18	13.9	30	32	26.0	22.0	47.8	57.9
DR22M-20M	22	20	15.1	30	32	26.0	22.0	49.3	59.4
DR22M-25M	22	25	18.3	30	32	26.0	22.0	54.1	64.2
DR25M-18M	25	18	13.9	35	38	31.3	26.5	50.8	63.1
DR25M-20M	25	20	15.1	35	38	31.3	26.5	52.3	64.6

Bulkhead Adapter

DAB

The bulkhead adapter is useful to help set a direction through panel construction.

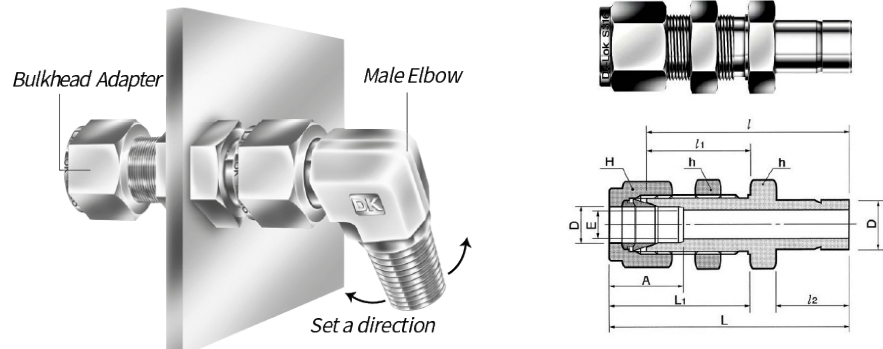

Connects fractional tube to fractional DK-Lok port

Part No.	Tube O.D. D		E Min.	Width across flat				A	ℓ	ℓ1	ℓ2	L	L1	Panel Hole Drill size	Panel Max Thickness
	in.	mm		h		H									
				in.	mm	in.	mm								
DAB2-2	1/8	3.17	2.03	1/2	12.70	7/16	11.11	12.70	42.92	24.63	13.45	49.53	31.24	8.33	12.70
DAB4-4	1/4	6.35	4.82	5/8	15.87	9/16	14.28	15.24	48.51	26.16	15.74	55.88	33.52	11.50	10.16
DAB6-6	3/8	9.52	7.11	3/4	19.05	11/16	17.46	16.76	53.84	29.46	17.50	61.21	36.83	14.68	11.17
DAB8-8	1/2	12.70	10.41	15/16	23.81	7/8	22.22	22.86	62.73	31.75	23.11	72.89	41.91	19.44	12.70
DAB10-10	5/8	15.87	12.70	1-1/16	26.98	1	25.40	24.38	65.02	32.51	24.70	75.18	42.67	22.62	12.70
DAB16-16	1	25.40	20.32	1-5/8	41.28	1-1/2	38.10	31.24	88.13	45.21	31.70	100.33	57.40	33.73	19.05
DAB20-20	1-1/4	31.75	27.68	1-7/8	47.63	1-7/8	47.63	41.14	102.07	47.75	40.00	124.17	69.85	41.67	19.05
DAB24-24	1-1/2	38.10	34.03	2-1/4	57.15	2-1/4	57.15	50.03	118.33	49.27	51.50	145.51	76.45	49.61	19.05
DAB32-32	2	50.80	45.97	2-3/4	69.85	3	76.20	67.56	148.79	56.38	68.40	185.82	93.71	57.94	19.05

Male Adapter

DAM-N



Connects metric DK-Lok port to female NPT thread

Part No.	Tube O.D. D	T PT	E Min.	E1 Min.	Width across flat h	ℓ	L
DAM3M-2N	3	1/8	4.0	1.9	12	13.15	29.4
DAM6M-2N	6	1/8	4.6	4.1	12	15.70	32.8
DAM6M-4N	6	1/4	4.6	4.1	14	15.70	38.1
DAM8M-4N	8	1/4	6.3	5.6	14	16.80	39.1
DAM10M-4N	10	1/4	7.7	7.1	14	17.50	39.9
DAM10M-6N	10	3/8	7.7	7.1	17	17.50	40.6
DAM10M-8N	10	1/2	11.9	7.1	22	17.50	45.2
DAM12M-4N	12	1/4	7.1	8.8	14	23.10	46.5
DAM12M-6N	12	3/8	9.1	8.8	17	23.10	46.5
DAM12M-8N	12	1/2	11.9	8.8	22	23.10	51.8
DAM18M-8N	18	1/2	11.9	13.9	22	24.60	53.2
DAM18M-12N	18	3/4	15.9	13.9	27	24.60	53.2
DAM28M-16N	28	1	22.2	-	35	31.70	74.7
DAM28M-20N	28	1-1/4	23.8	-	46	31.70	76.2
DAM32M-20N	32	1-1/4	27.4	-	46	40.00	81.0
DAM38M-24N	38	1-1/2	33.3	-	55	51.50	92.2

Male Adapter DAM-N

Connects fractional DK-Lok port to female NPT thread

Part No.	Tube O.D. D		T NPT	E Min.	E1	Width across flat h		ℓ	L
	in.	mm				in.	mm		
DAM2-2N	1/8	3.17	1/8	2.28	2.00	7/16	11.11	13.45	29.50
DAM2-4N	1/8	3.17	1/4	6.35	2.00	9/16	14.28	13.45	34.80
DAM3-2N	3/16	4.76	1/8	3.04	3.04	7/16	11.11	14.20	30.22
DAM3-4N	3/16	4.76	1/4	6.35	3.04	9/16	14.28	14.20	35.56
DAM4-2N	1/4	6.35	1/8	4.57	4.30	7/16	11.11	15.75	31.80
DAM4-4N	1/4	6.35	1/4	6.35	4.30	9/16	14.28	15.75	37.08
DAM4-6N	1/4	6.35	3/8	7.93	4.30	11/16	17.46	15.75	37.84
DAM4-8N	1/4	6.35	1/2	11.90	4.30	7/8	22.22	15.75	43.43
DAM5-2N	5/16	7.93	1/8	2.28	5.50	7/16	11.11	16.80	32.76
DAM5-4N	5/16	7.93	1/4	6.35	5.50	9/16	14.28	16.80	38.10
DAM6-2N	3/8	9.52	1/8	4.82	6.80	7/16	11.11	17.50	33.50
DAM6-4N	3/8	9.52	1/4	7.11	6.80	9/16	14.28	17.50	38.90
DAM6-6N	3/8	9.52	3/8	7.93	6.80	11/16	17.46	17.50	39.60
DAM6-8N	3/8	9.52	1/2	11.90	6.80	7/8	22.22	17.50	45.20
DAM8-4N	1/2	12.70	1/4	6.35	9.30	9/16	14.28	23.20	44.50
DAM8-6N	1/2	12.70	3/8	7.93	9.30	11/16	17.46	23.20	45.20

DK-Lok Tube Stub Adapter eliminates alignment problems.

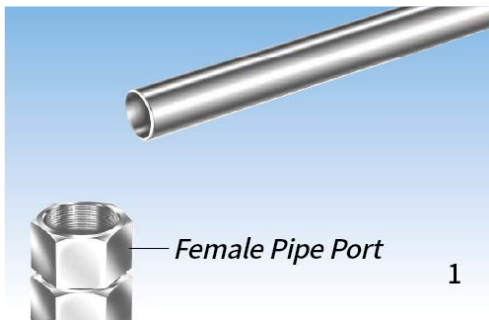

In the direction shown the female port is required to connect with tubing.

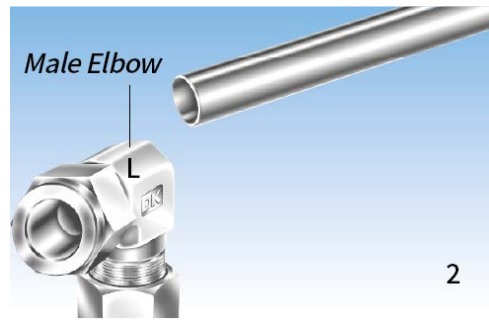

The male elbow is positioning in the wrong direction.

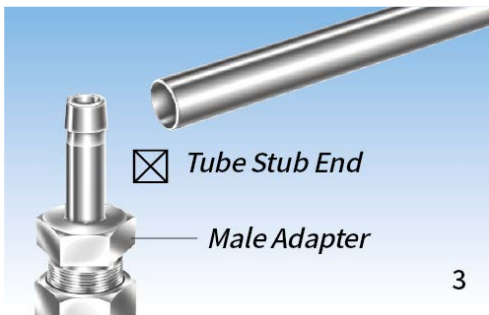

To eliminate the problem, use a male adapter into the female port.

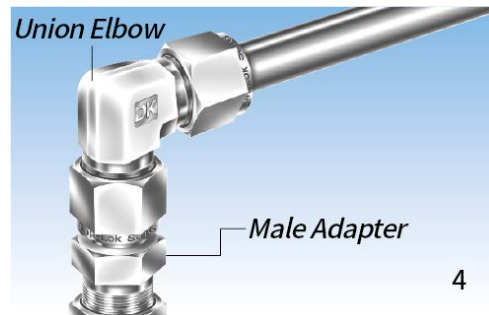

Installation instruction.

1. Insert the tube stub end into the DK-Lok port
 - Make sure that the tube stub end bottoms on the fitting body shoulder.
2. Spanner-tighten the nut 1 1/4 turns beyond the finger tight position.
 - Tighten the nut 3/4 turn for 1/8, and 3/16 in.; 3, and 4 mm Tube Fittings.

Note: For re-use, see re-assembly instruction.

Male Adapter
DAM-R

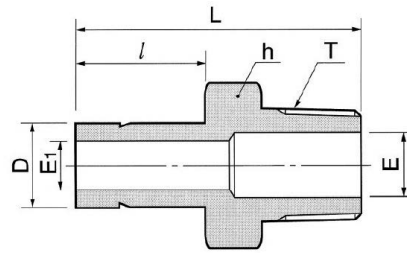
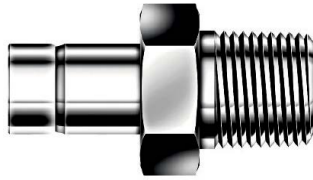

Connects fractional DK-Lok port to female ISO tapered thread

Part No.	Tube O.D. D		T PT	E Min.	E1	Width across flat h		ℓ	L
	in.	mm				in.	mm		
DAM2-2R	1/8	3.17	1/8	4.57	2.00	7/16	11.11	13.45	29.50
DAM2-4R	1/8	3.17	1/4	7.11	2.00	9/16	14.28	13.45	34.80
DAM4-2R	1/4	6.35	1/8	4.57	4.30	7/16	11.11	15.75	31.80
DAM4-4R	1/4	6.35	1/4	7.11	4.30	9/16	14.28	15.75	37.08
DAM4-6R	1/4	6.35	3/8	10.41	4.30	11/16	17.46	15.75	37.84
DAM6-4R	3/8	9.52	1/4	7.11	6.80	9/16	14.28	17.50	38.90
DAM6-6R	3/8	9.52	3/8	10.41	6.80	11/16	17.46	17.50	39.60
DAM6-8R	3/8	9.52	1/2	12.70	6.80	7/8	22.22	17.50	45.20
DAM8-4R	1/2	12.70	1/4	7.11	9.30	9/16	14.28	23.10	44.50
DAM8-6R	1/2	12.70	3/8	10.41	9.30	11/16	17.46	23.10	45.20
DAM8-8R	1/2	12.70	1/2	12.70	9.30	7/8	22.22	23.10	50.50
DAM8-12R	1/2	12.70	3/4	15.74	9.30	1-1/16	26.98	23.10	50.70
DAM12-8R	3/4	19.05	1/2	12.70	14.70	7/8	22.22	24.70	52.30
DAM12-12R	3/4	19.05	3/4	14.98	14.70	1-1/16	26.98	24.70	52.30

Connects metric DK-Lok port to female ISO tapered thread

Part No.	Tube O.D. D	T PT	E Min.	E1	Width across flat h	ℓ	L
DAM3M-2R	3	1/8	4.0	1.9	12	13.15	29.4
DAM6M-2R	6	1/8	4.6	4.1	12	15.70	32.8
DAM6M-4R	6	1/4	4.6	4.1	14	15.70	38.1
DAM8M-4R	8	1/4	6.3	5.6	14	16.80	39.1
DAM10M-4R	10	1/4	7.7	7.1	14	17.50	39.9
DAM10M-6R	10	3/8	7.7	7.1	17	17.50	40.6
DAM10M-8R	10	1/2	11.9	7.1	22	17.50	45.2
DAM12M-4R	12	1/4	7.1	8.8	14	23.10	46.5
DAM12M-6R	12	3/8	9.1	8.8	17	23.10	46.5
DAM12M-8R	12	1/2	11.9	8.8	22	23.10	51.8
DAM18M-8R	18	1/2	11.9	13.9	22	24.60	53.2
DAM18M-12R	18	3/4	15.9	13.9	27	24.60	53.2
DAM25M-16R	25	1	19.8	19.8	35	31.70	66.0
DAM28M-16R	28	1	22.2	-	35	31.70	74.7
DAM28M-20R	28	1-1/4	23.8	-	46	31.70	76.2
DAM30M-20R	30	1-1/4	24.6	-	46	40.60	80.0
DAM32M-20R	32	1-1/4	27.4	-	46	40.00	81.0
DAM38M-24R	38	1-1/2	33.3	-	55	51.50	92.2

Male Adapter
DAM-G

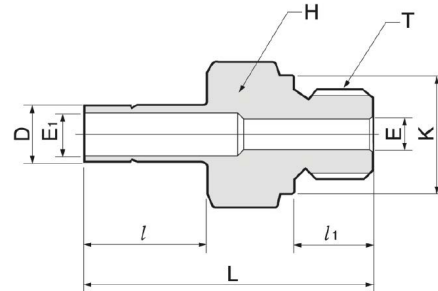

Connects fractional DK-Lok port to female ISO parallel thread

Part No.	Tube O.D. D		T PF	E Min.	E1	Width across flat h		ℓ	ℓ1	L	K
	in.	mm				in.	mm				
DAM2-2G	1/8	3.17	1/8	4	2.00	9/16	14.28	13.45	7.10	40.0	13.8
DAM2-4G	1/8	3.17	1/4	6.4	2.00	3/4	19.05	13.45	11.2	35.8	18.0
DAM4-2G	1/4	6.35	1/8	4.57	4.30	9/16	14.28	15.75	7.10	33.27	13.8
DAM4-4G	1/4	6.35	1/4	4.57	4.30	3/4	19.05	15.75	11.2	38.1	18.0
DAM6-4G	3/8	9.52	1/4	5.9	6.80	3/4	19.05	17.50	11.2	39.8	18.0
DAM6-6G	3/8	9.52	3/8	7.11	6.80	7/8	22.22	17.5	11.2	40.64	21.8
DAM8-4G	1/2	12.70	1/4	5.9	9.30	3/4	19.05	23.1	11.2	45.5	18.0
DAM8-6G	1/2	12.70	3/8	7.9	9.30	7/8	22.22	23.1	11.2	46.2	21.8
DAM8-8G	1/2	12.70	1/2	11.9	9.30	1-1/16	26.98	23.1	14.2	49.3	26.0
DAM12-12G	3/4	19.05	3/4	14.98	14.70	1-5/16	33.33	24.7	15.7	54.86	32.0
DAM16-16G	1	25.40	1	20.06	20.00	1-5/8	41.28	31.7	18.3	64.5	39.0

Connects metric DK-Lok port to female ISO parallel thread

Part No.	Tube O.D. D	T PF	E Min.	E1	Width across flat h	ℓ	ℓ1	L	K
DAM6M-2G	6	1/8	4.6	4.1	14	15.7	7.1	34.3	13.8
DAM6M-4G	6	1/4	4.6	4.1	19	15.7	11.2	39.1	18.0
DAM8M-4G	8	1/4	5.9	5.6	19	16.8	11.2	40.1	18.0
DAM10M-4G	10	1/4	5.9	7.1	19	17.5	11.2	40.9	18.0
DAM10M-6G	10	3/8	7.7	7.1	22	17.5	11.2	41.7	21.8
DAM10M-8G	10	1/2	7.7	7.1	27	17.5	14.2	44.7	26.0
DAM12M-4G	12	1/4	5.9	8.8	19	23.1	11.2	46.7	18.0
DAM12M-6G	12	3/8	7.9	8.8	22	23.1	11.2	47.2	21.8
DAM12M-8G	12	1/2	9.1	8.8	27	23.1	14.2	50.5	26.0
DAM18M-8G	18	1/2	11.9	13.9	27	24.6	14.2	52.1	26.0
DAM18M-12G	18	3/4	15.9	13.9	35	24.6	15.7	56.1	32.0
DAM22M-12G	22	3/4	15.9	18.3	35	26.6	15.7	57.4	32.0
DAM25M-16G	25	1	19.8	19.8	41	31.7	18.3	67.1	39.0
DAM28M-16G	28	1	19.8	22.2	41	37.5	18.3	72.9	39.0
DAM28M-20G	28	1-1/4	23.8	23.8	50	37.5	19.8	77.0	49.0
DAM30M-20G	30	1-1/4	24.6	24.3	50	40.66	19.8	80.8	49.0
DAM32M-20G	32	1-1/4	25.0	26.5	50	40.0	19.8	81.8	49.0
DAM38M-24G	38	1-1/2	31.8	31.6	55	50.4	22.1	94.5	54.7

Male Adapter
DAM-U

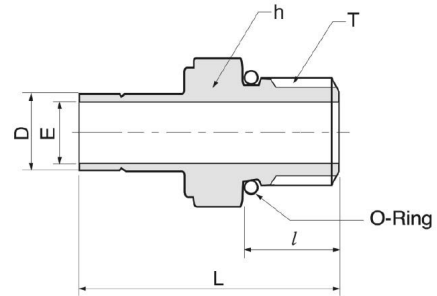
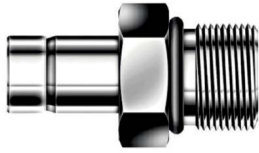

Connects fractional DK-Lok port to SAE straight thread boss

Part No.	Tube O.D. D		T U	E Min.	Width across flat h		ℓ	L	O-Ring Uniform Size Number
	in.	mm			in.	mm			
DAM2-2U	1/8	3.17	5/16-24	2.00	7/16	11.11	7.62	30.48	-902
DAM4-4U	1/4	6.35	7/16-20	4.30	9/16	14.28	9.14	35.30	-904
DAM6-4U	3/8	9.52	7/16-20	6.80	9/16	14.28	9.14	37.08	-904
DAM6-6U	3/8	9.52	9/16-18	6.80	11/16	17.46	9.90	38.60	-906
DAM6-8U	3/8	9.52	3/4-16	6.80	7/8	22.22	11.17	40.64	-908
DAM8-6U	1/2	12.70	9/16-18	9.30	11/16	17.46	9.90	44.20	-906
DAM8-8U	1/2	12.70	3/4-16	9.30	7/8	22.22	11.17	46.22	-908
DAM12-12U	3/4	19.05	1-1/16-12	14.70	1-1/4	31.75	14.98	53.34	-912
DAM16-16U	1	25.4	1-5/16-12	20.00	1-1/2	38.1	14.98	61.21	-916

Male Adapter
DAM-UO

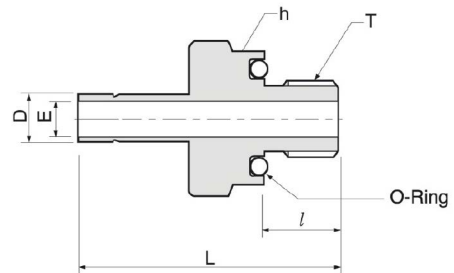

Connects fractional DK-Lok port to SAE straight thread boss

Part No.	Tube O.D. D		T U	E Min.	Width across flat h		ℓ	L	O-Ring Uniform Size Number
	in.	mm			in.	mm			
DAM2-2UO	1/8	3.17	5/16-24	2.00	9/16	14.28	8.63	32.51	-011
DAM3-3UO	3/16	4.76	3/8-24	3.05	5/8	15.87	9.65	35.05	-012
DAM4-4UO	1/4	6.35	7/16-20	4.30	3/4	19.05	10.41	39.11	-013
DAM5-5UO	5/16	7.93	1/2-20	5.50	7/8	22.22	11.17	41.65	-112
DAM6-6UO	3/8	9.52	9/16-18	6.80	15/16	23.81	11.93	43.18	-113
DAM8-8UO	1/2	12.7	3/4-16	9.30	1-1/8	28.57	11.93	49.53	-116

Female Adapter
DAF-N

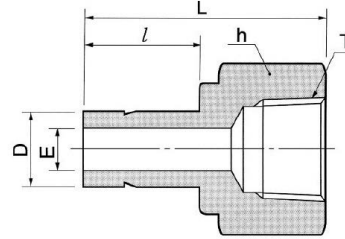

Connects fractional DK-Lok port to male NPT thread

Part No.	Tube O.D. D		T NPT	E Min.	Width across flat h		ℓ	L
	in.	mm			in.	mm		
DAF2-2N	1/8	3.17	1/8	2.00	9/16	14.28	13.45	31.50
DAF2-4N	1/8	3.17	1/4	2.00	3/4	19.05	13.45	35.30
DAF3-2N	3/16	4.76	1/8	3.04	9/16	14.28	14.20	32.00
DAF3-4N	3/16	4.76	1/4	3.04	3/4	19.05	14.20	35.81
DAF4-2N	1/4	6.35	1/8	4.30	9/16	14.28	15.75	33.02
DAF4-4N	1/4	6.35	1/4	4.30	3/4	19.05	15.75	37.10
DAF4-6N	1/4	6.35	3/8	4.30	7/8	22.22	15.75	39.37
DAF4-8N	1/4	6.35	1/2	4.30	1-1/16	26.98	15.75	45.50
DAF5-2N	5/16	7.93	1/8	5.50	9/16	14.28	16.80	34.29
DAF5-4N	5/16	7.93	1/4	5.50	3/4	19.05	16.80	37.59
DAF6-2N	3/8	9.52	1/8	6.80	9/16	14.28	17.50	34.29
DAF6-4N	3/8	9.52	1/4	6.80	3/4	19.05	17.50	38.10
DAF6-6N	3/8	9.52	3/8	6.80	7/8	22.22	17.50	40.38
DAF6-8N	3/8	9.52	1/2	6.80	1-1/16	26.98	17.50	46.73
DAF8-4N	1/2	12.70	1/4	9.30	3/4	19.05	23.20	43.43
DAF8-6N	1/2	12.70	3/8	9.30	7/8	22.22	23.20	45.46
DAF8-8N	1/2	12.70	1/2	9.30	1-1/16	26.98	23.20	51.80
DAF10-6N	5/8	15.87	3/8	12.70	7/8	22.22	24.70	48.26
DAF10-8N	5/8	15.87	1/2	12.70	1-1/16	26.98	24.70	53.84
DAF10-12N	5/8	15.87	3/4	12.70	1-5/16	33.33	24.70	55.37
DAF12-8N	3/4	19.05	1/2	14.70	1-1/16	26.98	24.70	52.83
DAF12-12N	3/4	19.05	3/4	14.70	1-5/16	33.33	24.70	54.86
DAF12-16N	3/4	19.05	1	14.70	1-5/8	41.27	24.70	58.42
DAF14-12N	7/8	22.22	3/4	17.27	1-5/16	33.33	26.70	57.15
DAF16-12N	1	25.40	3/4	20.00	1-5/16	33.33	31.70	60.70
DAF16-16N	1	25.40	1	20.00	1-5/8	41.27	31.70	64.26
DAF20-20N	1-1/4	31.75	1-1/4	27.68	2-1/8	53.98	40.00	77.72
DAF24-24N	1-1/2	38.10	1-1/2	31.70	2-3/8	60.33	51.50	88.90
DAF32-32N	2	50.80	2	43.60	2-7/8	73.03	68.40	107.44

Connects metric DK-Lok port to male NPT thread

Part No.	Tube O.D. D	T NPT	E Min.	Width across flat h	E	L
DAF6M-2N	6	1/8	4.1	14	15.70	32.50
DAF6M-4N	6	1/4	4.1	19	15.70	37.10
DAF8M-4N	8	1/4	5.6	19	16.80	37.60
DAF10M-4N	10	1/4	7.1	19	17.50	38.10
DAF10M-6N	10	3/8	7.1	22	17.50	40.10
DAF10M-8N	10	1/2	7.1	27	17.50	46.50
DAF12M-4N	12	1/4	8.8	19	23.10	43.70
DAF12M-6N	12	3/8	8.8	22	23.10	46.00
DAF12M-8N	12	1/2	8.8	27	23.10	52.30

Female Adapter
DAF-R

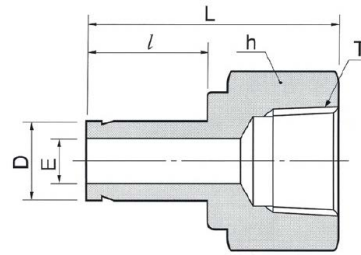

Connects fractional DK-Lok port to male ISO tapered thread

Part No.	Tube O.D. D		T PT	E Min.	Width across flat h		ℓ	L
	in.	mm			in.	mm		
DAF4-2R	1/4	6.35	1/8	4.30	9/16	14.28	15.75	33.02
DAF4-4R	1/4	6.35	1/4	4.30	3/4	19.05	15.75	37.10
DAF6-4R	3/8	9.52	1/4	6.80	3/4	19.05	17.50	38.10
DAF6-6R	3/8	9.52	3/8	6.80	7/8	22.22	17.50	40.38
DAF8-4R	1/2	12.70	1/4	9.30	3/4	19.05	23.20	43.43
DAF8-6R	1/2	12.70	3/8	9.30	7/8	22.22	23.20	45.46
DAF8-8R	1/2	12.70	1/2	9.30	1-1/16	26.98	23.20	51.80
DAF10-8R	5/8	15.87	1/2	12.70	1-1/16	26.98	24.70	53.84
DAF12-8R	3/4	19.05	1/2	14.70	1-1/16	26.98	24.70	52.83
DAF12-12R	3/4	19.05	3/4	14.70	1-5/16	33.33	24.70	54.86
DAF16-16R	1	25.40	1	20.00	1-5/8	41.27	31.70	64.26

Connects metric DK-Lok port to male ISO tapered thread

Part No.	Tube O.D. D	T PT	E Min.	Width across flat h	ℓ	L
DAF6M-2R	6	1/8	4.1	14	15.70	32.50
DAF6M-4R	6	1/4	4.1	19	15.70	37.10
DAF8M-4R	8	1/4	5.6	19	16.80	37.60
DAF10M-4R	10	1/4	7.1	19	17.50	38.10
DAF10M-6R	10	3/8	7.1	22	17.50	40.10
DAF12M-4R	12	1/4	8.8	19	23.10	43.70
DAF12M-6R	12	3/8	8.8	22	23.10	46.00
DAF12M-8R	12	1/2	8.8	27	23.10	52.30

Female Adapter
DAF-GR

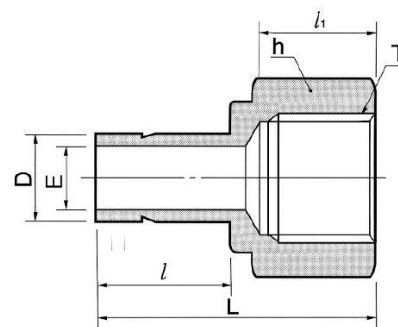

Connects fractional DK-Lok port to male ISO parallel thread

Part No.	Tube O.D. D		T PF	E Min.	Width across flat h		ℓ	ℓ1	L
	in.	mm			in.	mm			
DAF4-2GR	1/4	6.35	1/8	4.30	9/16	14.28	15.75	13.0	31.75
DAF4-4GR	1/4	6.35	1/4	4.30	3/4	19.05	15.75	18.5	38.10
DAF6-4GR	3/8	9.52	1/4	6.80	3/4	19.05	17.50	18.5	39.40
DAF6-6GR	3/8	9.52	3/8	6.80	7/8	22.22	17.50	18.5	39.90
DAF8-8GR	1/2	12.70	1/2	9.30	1-1/16	26.98	23.20	22.1	49.50

Connects metric DK-Lok port to male ISO parallel thread

Part No.	Tube O.D. D	T PF	E Min.	Width across flat h	ℓ	ℓ1	L
DAF6M-2GR	6	1/8	4.6	14	15.70	13.0	32.50
DAF6M-4GR	6	1/4	4.6	19	15.70	18.5	37.80
DAF12M-8GR	12	1/2	9.1	27	23.10	22.1	49.50

Female Gauge Adapter (previously DAG)

DAF-GG

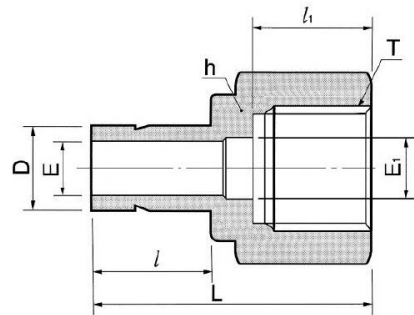

Connects fractional DK-Lok port to Gauge (Male ISO parallel thread)

Part No.	Tube O.D. D		T G(PF)	E Min.	E1	Width across flat h		ℓ	ℓ1	L
	in.	mm				in.	mm			
DAF4-2GG	1/4	6.35	1/8	4.30	4.57	9/16	14.28	15.75	12.0	32.00
DAF4-4GG	1/4	6.35	1/4	4.30	5.5	3/4-	19.05	15.75	12.9	35.30
DAF6-6GG	3/8	9.52	3/8	6.80	6.5	15/16	23.81	17.50	14.1	39.37
DAF8-8GG	1/2	12.7	1/2	9.30	7.0	1-1/16	26.98	23.20	18.9	45.72

Connects Metric DK-Lok port to Gauge (Male ISO parallel thread)

Part No.	Tube O.D. D	T G(PF)	E Min.	E1	Width across flat h	ℓ	ℓ1	L
DAF6M-2GG	6M	1/8	4.1	4.0	14	15.7	12.0	32.0
DAF6M-4GG	6M	1/4	4.1	5.5	19	15.7	13.0	35.3
DAF6M-6GG	6M	3/8	4.1	6.5	24	15.7	14.22	38.4
DAF6M-8GG	6M	1/2	4.1	7.0	27	15.7	18.9	42.9
DAF8M-4GG	8M	1/4	5.6	5.5	19	16.8	13.0	33.0
DAF8M-6GG	8M	3/8	5.6	6.5	24	16.8	14.22	39.3
DAF8M-8GG	8M	1/2	5.6	7.0	27	16.8	18.9	43.7
DAF10M-4GG	10M	1/4	7.1	5.5	19	17.5	13.0	34.5
DAF10M-6GG	10M	3/8	7.1	6.5	24	17.5	14.22	39.3
DAF10M-8GG	10M	1/2	7.1	7.0	27	17.5	18.9	40.1
DAF12M-4GG	12M	1/4	8.8	5.5	19	23.1	13.0	40.1
DAF12M-6GG	12M	3/8	8.8	6.5	24	23.1	14.22	44.9
DAF12M-8GG	12M	1/2	8.8	7.0	27	23.1	18.9	48.8
DAF15M-8GG	15M	1/2	11.2	7.0	27	24.65	18.9	49.0
DAF16M-8GG	16M	1/2	12.0	7.0	27	24.6	18.9	49.0
DAF18M-8GG	18M	1/2	13.9	7.0	27	24.9	18.9	49.3
DAF22M-8GG	22M	1/2	18.3	7.0	27	26.6	18.9	52.0
DAF25M-8GG	25M	1/2	19.8	7.0	30	31.7	18.9	56.1

**Elbow Adapter
DLA**

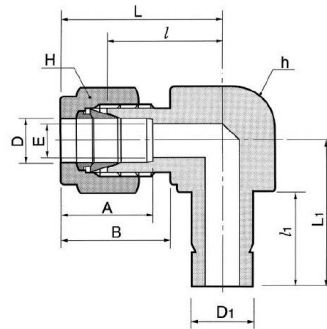

Connects metric tube to metric DK-Lok port

Part No.	Tube O.D. D	D1	E Min.	Width across flat		A	B	ℓ	ℓ1	L	L1
				h	H						
DLA-6M	6	6	4.6	12.7	14	15.3	17.7	19.6	15.7	27.0	25.0
DLA-8M	8	8	6.4	15.8	16	16.2	18.6	21.3	16.8	28.8	27.05
DLA-10M	10	10	7.7	17.4	19	17.2	19.5	23.9	17.5	31.5	30.0
DLA-12M	12	12	9.1	20.6	22	22.8	22.0	25.9	23.1	36.0	37.3
DLA-14M	14	14	11.1	25.4	25	24.4	22.0	28.7	24.6	38.8	41.5
DLA-15M	15	15	11.9	25.4	25	24.4	22.0	28.7	24.65	38.8	41.55
DLA-16M	16	16	12.7	25.4	25	24.4	22.0	28.7	24.6	38.8	41.5
DLA-18M	18	18	13.9	26.9	30	24.4	22.0	29.7	24.6	39.8	42.5
DLA-20M	20	20	15.1	31.8	32	26.0	22.0	32.5	26.2	42.6	47.0
DLA-22M	22	22	18.3	31.8	32	26.0	22.0	32.5	26.6	42.6	47.15
DLA-25M	25	25	19.8	34.9	38	31.3	26.5	36.8	31.7	49.1	55.2
DLA-28M	28	28	21.8	41.0	46	36.6	36.6	43.2	37.5	64.0	64.9

**Run Tee Adapter
DTRA**

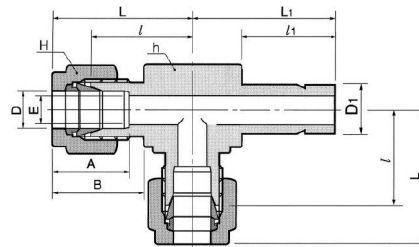

Connects metric tube to metric DK-Lok port

Part No.	Tube O.D. D	D1	E Min.	Width across flat		A	B	ℓ	ℓ1	L	L1
				h	H						
DTRA-8M	8	8	6.4	15.8	16	16.2	18.6	21.3	16.8	28.8	27.5
DTRA-10M	10	10	7.9	17.4	19	17.2	19.5	23.9	17.5	31.5	30.0

**Branch Tee Adapter
DTBA**

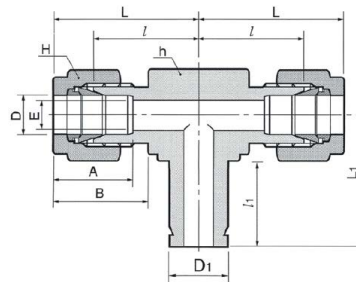

Connects metric tube to metric DK-Lok port

Part No.	Tube O.D. D	D1	E Min.	Width across flat		A	B	ℓ	ℓ1	L	L1
				h	H						
DTBA-8M	8	8	6.4	15.8	16	16.2	18.6	21.3	16.8	28.8	27.5

Port Connector DCP/DCPZ

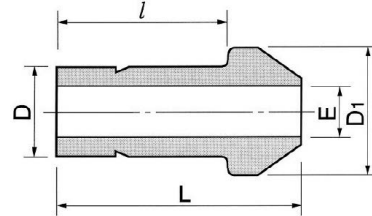
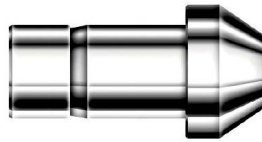

Connects two fractional DK-Lok ports

Part No.	Tube O.D. D		E Min.	D1	ℓ	L
	in.	mm				
DCP-1	1/16	1.59	0.70	3.30	10.66	13.72
DCP-2	1/8	3.17	2.00	6.09	15.75	22.35
DCP-4	1/4	6.35	4.30	9.39	18.79	24.64
DCP-5	5/16	7.93	5.50	10.92	20.06	25.90
DCP-6	3/8	9.52	6.80	12.70	20.32	26.16
DCP-8	1/2	12.70	9.30	15.74	25.90	35.81
DCP-12	3/4	19.05	14.70	22.09	27.68	37.33
DCP-16	1	25.40	20.00	28.44	34.54	48.00
DCPZ-1	1/16	1.59	0.70	3.30	10.66	13.72
DCPZ-2	1/8	3.17	2.00	6.09	15.75	22.35
DCPZ-4	1/4	6.35	4.30	9.39	18.79	24.64
DCPZ-5	5/16	7.93	5.50	10.92	20.06	25.90
DCPZ-6	3/8	9.52	6.80	12.70	20.32	26.16
DCPZ-8	1/2	12.70	9.30	15.74	25.90	35.81
DCPZ-12	3/4	19.05	14.70	22.09	27.68	37.33
DCPZ-16	1	25.40	20.00	28.44	34.54	48.00

Connects two metric DK-Lok ports

Part No.	Tube O.D. D	E Min.	D1	ℓ	L
DCP-3M	3	1.9	6.0	15.70	22.20
DCP-4M	4	1.9	7.0	16.67	25.81
DCP-6M	6	4.1	9.0	18.70	24.60
DCP-8M	8	5.6	11.0	20.00	25.90
DCP-10M	10	7.1	13.1	20.20	26.10
DCP-12M	12	8.8	15.0	26.00	35.80
DCP-15M	15	11.2	19.0	27.78	37.40
DCP-16M	16	12.0	19.0	27.60	37.40
DCP-18M	18	13.9	21.0	27.91	37.40
DCP-20M	20	15.1	23.0	29.20	38.90
DCP-22M	22	17.9	24.97	29.30	39.20
DCP-25M	25	19.8	28.0	35.60	49.50
DCP-28M	28	23.8	34.3	48.30	63.50
DCP-32M	32	26.5	39.5	52.40	69.70
DCP-38M	38	31.6	47.1	61.40	81.90

Installation Instructions

Machined Ferrule End and Tube Stub End

Port Connector is useful for close connection of two DK-Lok ports.

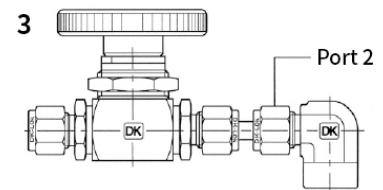
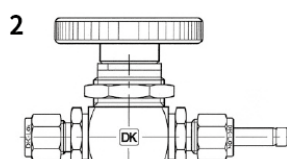
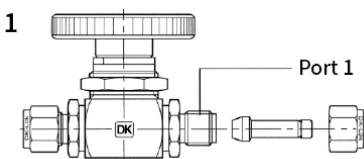

Be aware that Port Connector consists of machined ferrule end, and tube stub end. These two ends require different installation.

Machined Ferrule End

Refers to Fig. 1 & 2.

1. Remove the nut and ferrules from DK-Lok port 1.
2. Place the nut over the machined ferrule end of the port connector.
3. Finger-tighten the nut onto the port 1.
4. Wrench-tighten the nut 1/4 turn, keeping the body steady with a backup wrench.
 - Do not tighten 1 1/4 turns. This is not the standard ferrule.
 - Tightens 1/8 turn for 1/16, and 1/8 in.; 3, and 4mm Tube Fittings.

Tube Stub End

Refers to Fig. 3.

1. Insert the tube stub end into the port 2 until it is bottomed on the shoulder of the body.
2. Finger-tighten the nut on port 2.
3. Wrench-tighten the nut 1 1/4 turns, keeping the port 2 body steady with a backup wrench.
 - Tighten the nut 3/4 turn for 1/16. and 1/8 in.; and 3, and 4mm Tube Fittings.
 - For re-use, see re-assembly instruction.

Reducing Port Connector
DCRP

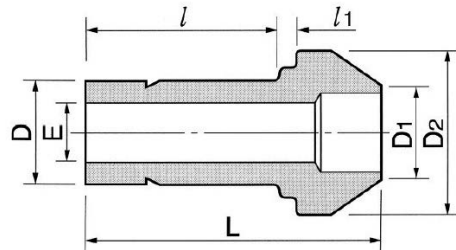
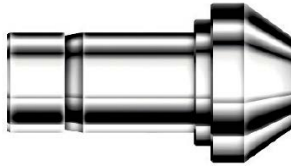

Connects two fractional DK-Lok ports

Part No.	Tube O.D.				E Min.	D2	ℓ	ℓ1	L
	D1		D						
	in.	mm	in.	mm					
DCRP2-1	1/8	3.17	1/16	1.59	0.70	6.10	8.64	2.03	17.27
DCRP4-2	1/4	6.35	1/8	3.17	2.00	9.39	13.45	3.30	22.60
DCRP6-2	3/8	9.52	1/8	3.17	2.00	12.70	13.45	3.81	23.11
DCRP6-4	3/8	9.52	1/4	6.35	4.30	12.70	15.75	3.30	24.89
DCRP8-4	1/2	12.70	1/4	6.35	4.30	15.74	15.75	3.81	29.21
DCRP8-6	1/2	12.70	3/8	9.52	6.80	15.74	17.67	3.30	30.48
DCRP12-8	3/4	19.05	1/2	12.70	9.30	22.09	23.20	3.81	37.85
DCRP16-8	1	25.40	1/2	12.70	9.30	28.40	24.47	4.82	42.67
DCRP16-12	1	25.40	3/4	19.05	14.70	28.40	25.90	4.06	43.43

Connects two Metric DK-Lok ports

Part No.	Tube O.D.		E Min.	D2	ℓ	ℓ1	L
	D1	D					
DCRP6M-3M	6	3	1.9	9.0	13.50	3.2	22.60
DCRP8M-6M	8	6	4.1	11.0	15.70	3.1	24.70
DCRP10M-6M	10	6	4.1	13.1	15.70	3.4	25.00
DCRP10M-8M	10	8	5.6	13.1	16.80	3.1	26.00
DCRP12M-6M	12	6	4.1	15.0	15.70	3.6	29.10
DCRP12M-8M	12	8	5.6	15.0	16.80	3.4	29.80
DCRP12M-10M	12	10	7.1	15.0	17.50	3.1	30.40
DCRP16M-6M	16	6	4.1	19.0	15.75	3.6	30.40
DCRP16M-12M	16	12	8.8	19.0	23.10	3.4	36.20
DCRP28M-25M	28	25	19.8	34.3	33.00	8.2	56.50
DCRP32M-25M	32	25	19.8	39.5	33.00	9.9	60.30
DCRP38M-25M	38	25	19.8	47.1	33.00	12.3	65.80

DK-Lok Flanges ANSI B16.5
DF

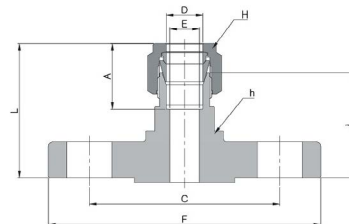

Pressure Class Ratings 150 to 2500 Nominal Flange Sizes NPS 1/2 to 2 in. Connects ANSI flange to fractional tube

Part No.	Tube O.D.		ANSI Flange NPS	ANSI Class	E	Wrench Flat h	A	ℓ	L	C	F
	in.	mm									
DF-4TF8-150	1/4	6.35	1/2	150	4.82	20.64	15.24	33.52	40.89	60.45	88.9
DF-4TF16-150			1	150	4.82	20.64	15.24	36.35	43.71	79.2	108
DF-6TF8-150	3/8	9.52	1/2	150	4.82	20.64	16.76	34.85	42.21	60.45	88.9
DF-6TF8-300			1/2	300	7.11	20.64	16.76	38.1	45.46	66.54	95.25
DF-6TF16-150	1/2	12.7	1	150	7.11	20.64	16.76	37.85	45.21	79.2	108
DF-8TF8-150			1/2	150	10.41	20.64	22.86	30.05	45.21	60.45	88.9
DF-8TF8-300	1/2	12.7	1/2	300	10.41	20.64	22.86	37.85	48.01	66.54	95.25
DF-8TF8-1500			1/2	1500	10.41	20.64	22.86	46.05	56.21	82.6	121
DF-8TF16-150	1/2	12.7	1	150	10.41	20.64	22.86	38.1	48.26	79.24	48.26
DF-8TF32-150			2	150	10.41	20.64	22.86	42.92	53.08	42.92	53.08
DF-12TF16-150	3/4	19.05	1	150	15.74	31.75	24.38	40.13	50.29	79.24	107.95
DF-12TF16-900			1	900	15.74	31.75	24.38	46.05	56.21	101.6	149
DF-16TF16-150	1	25.4	1	150	22.35	34.92	31.24	48.26	60.45	79.24	107.95
DF-24TF32-150	1-1/2	38.1	2	150	34.03	53.97	50.03	59.18	86.36	120.65	152.4
DF-32TF32-150	2	50.8	2	150	45.97	69.85	67.56	67.05	104.39	120.65	152.4

Dk-Lok Flanges DIN 2526/ DIN 2501

DF

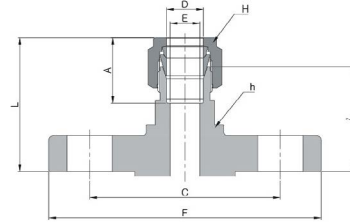

Pressure Class Rating PN 40 to 320, Nominal Flange Sizes DN 15 to 50 Connects DIN flange to metric tube

Part No.	Tube O.D. D	DIN Flange Size, DN	DIN CLASS	E	Wrench Flat h	A	ℓ	L	C	F
DF-6MF25M-40	6 mm	25	40	4.8	20	15.3	40.1	47.5	85.0	115.0
DF-12MF15M-40	12 mm	15	40	9.5	20	22.8	38.4	48.5	65.0	95.0
DF-12MF25M-40		25	40	9.5	20	22.8	40.4	50.5	85.0	115.0
DF-12MF50M-40		50	40	9.5	20	22.8	45.2	55.3	125.0	165.0
DF-18MF15M-40	18 mm	15	40	15.1	32	24.4	41.7	51.8	65.0	95.0
DF-18MF25M-40		25	40	15.1	32	24.4	43.7	53.8	85.0	115.0
DF-25MF25M-40	25 mm	25	40	21.8	35	31.3	51.8	64.0	85.0	115.0
DF-38MF50M-40	38 mm	50	40	33.7	55	49.4	62.7	90.4	125.0	165.0
DF-50MF50M-40	50 mm	50	40	45.2	70	65.0	66.3	103.0	125.0	165.0

JIS B 2220: Pressure Class Rating 10 to 63K, Nominal Flange Sizes DN 15 to 50 Connects JIS flange to fractional or metric tube

Part No.	Tube O.D. D		JIS Flange Size, DN	JIS Class	E	Wrench Flat h	A	ℓ	L	C	F
	in.	mm									
DF-4T15A10RF	1/4	6.35	15	10K	4.82	23.81	15.24	34.79	42.16	70.10	94.99
DF-6T15A10RF	3/8	9.52	15	10K	7.11	23.81	16.76	36.32	43.68	70.10	94.99
DF-8T15A10RF	1/2	12.7	15	10K	10.41	23.81	22.86	36.32	46.48	70.10	94.99
DF-12T15A10RF	3/4	19.05	15	10K	15.74	31.75	24.38	38.35	48.51	70.10	94.99
DF-16T25A10RF	1	25.4	25	10K	22.35	34.91	31.24	48.76	60.96	89.91	124.96
DF-32T50A10RF	2	50.8	50	10K	45.97	69.85	67.56	64.51	101.85	119.88	154.94
DF-12M15A10FF	12 mm		15	10K	9.5	20	22.8	36.3	46.5	70.0	95.0
DF-18M15A10RF	18 mm		15	10K	15.1	32	24.4	38.4	48.5	70.0	95.0
DF-25M25A10RF	25 mm		25	10K	21.8	35	31.3	48.8	61.0	90.0	125.0

Lap Joint Flange Connector

DLJ

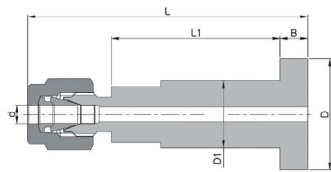

Installation

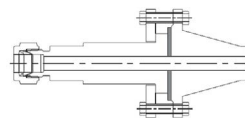

Lap joint flange connector installation with slip-on and welding neck flanges, using sealing gasket on the flange seal face.

Lap joint flange connector is designed to connect process flange to instrument. DK-Lok port is constructed integrally out of ANSI B16.5 Class 2500 flange, "Smooth" and "Concentric Serrated" flange seal face are available. External groove is provided to identify the serrated face.

Connects flange to fractional tube

Part No.	Tube O.D.		Dimension					
	in.	mm	L	L1	ℓ	D	D1	d Min.
Serrated Seal Face Flange								
DLJ-4T8F-SR-S	1/4	6.35	80.8	56.5	6.5	35	22.2	4.8
DLJ-6T8F-SR-S	3/8	9.52	82.3	56.5	6.5	35	22.2	7.1
DLJ-8T8F-SR-S	1/2	12.7	84.8	56.5	6.5	35	22.2	10.4
Smooth Seal Face Flange								
DLJ-4T8F-SM-S	1/4	6.35	80.8	56.5	6.5	35	22.2	4.8
DLJ-6T8F-SM-S	3/8	9.52	82.3	56.5	6.5	35	22.2	7.1
DLJ-8T8F-SM-S	1/2	12.7	84.8	56.5	6.5	35	22.2	10.4

Flange Seal Face



External Groove
Concentric Serrated : SR
Seal Face Roughness :
Ra 6.3 to 12.5 Micrometer



Smooth : SM
Seal Face Roughness:
Ra 3.2 to 6.3 Micrometer

AN Union
DUA

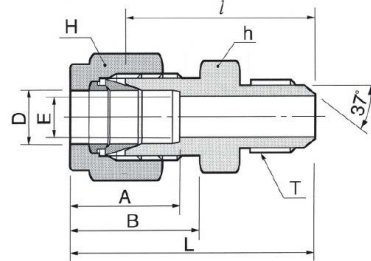

Connects fractional tube to AN flared tube

Part No.	Tube O.D. D		AN Tube Flare Size		Straight Thread T(U)	E Min.	Width across flat				A	B	ℓ	L
	in.	mm	in.	mm			h		H					
							in.	mm	in.	mm				
DUA1-2	1/16	1.59	1/8	3.17	5/16-24	1.27	7/16	11.11	5/16	7.93	8.63	10.92	23.36	27.17
DUA2-2	1/8	3.17	1/8	3.17	5/16-24	1.52	7/16	11.11	7/16	11.11	12.70	15.24	24.89	31.49
DUA2-4	1/8	3.17	1/4	6.35	7/16-20	2.28	1/2	12.70	7/16	11.11	12.70	15.24	28.44	35.05
DUA4-4	1/4	6.35	1/4	6.35	7/16-20	4.31	1/2	12.70	9/16	14.28	15.24	17.78	30.22	37.59
DUA5-5	5/16	7.93	5/16	7.93	1/2-20	5.84	9/16	14.28	5/8	15.87	16.25	18.54	30.98	38.35
DUA6-4	3/8	9.52	1/4	6.35	7/16-20	4.31	5/8	15.87	11/16	17.46	16.76	19.30	32.25	39.62
DUA6-6	3/8	9.52	3/8	9.52	9/16-18	7.11	5/8	15.87	11/16	17.46	16.76	19.30	32.25	39.62
DUA8-8	1/2	12.70	1/2	12.70	3/4-16	9.90	13/16	20.64	7/8	22.22	22.86	21.84	35.81	45.97
DUA12-12	3/4	19.05	3/4	19.05	1-1/16-12	15.49	1-1/8	28.58	1-1/8	28.58	24.38	21.84	43.18	53.34
DUA16-16	1	25.40	1	25.40	1-5/16-12	21.33	1-3/8	34.92	1-1/2	38.10	31.24	26.41	49.27	61.46
DUA20-20	1-1/4	31.75	1-1/4	31.75	1-5/8-12	27.68	1-3/4	44.45	1-7/8	47.63	41.14	38.86	55.46	77.56
DUA24-24	1-1/2	38.10	1-1/2	38.10	1-7/8-12	33.90	2-1/8	53.97	2-1/4	57.15	50.03	45.21	63.07	90.25
DUA32-32	2	50.80	2	50.80	2-1/2-12	45.97	2-3/4	69.85	3	76.20	67.56	62.73	83.24	120.57

DK-Lok AN fitting 37° Flare is designed to SAE J514 standard. AN fittings are used normally in Army and Navy instrumentation.

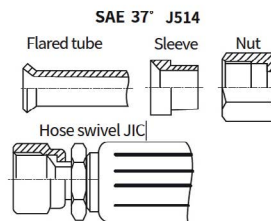

AN Bulkhead Union
DUBA

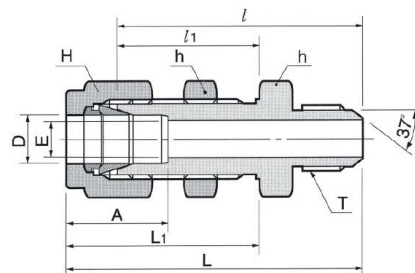

Connects fractional tube to AN flared tube

Part No.	Tube O.D. D		AN Tube Flare Size		Straight Thread T(U)	E Min.	Width across flat				A	ℓ	ℓ1	L	L1	Panel Hole Drill size	Panel Max Thickness
	in.	mm	in.	mm			h		H								
							in.	mm	in.	mm							
DUBA2-2	1/8	3.17	1/8	3.17	5/16-24	1.77	1/2	12.70	7/16	11.11	13.71	40.85	24.63	47.45	31.23	8.33	12.70
DUBA4-4	1/4	6.35	1/4	6.35	7/16-20	4.31	5/8	15.87	9/16	14.28	15.24	46.48	26.16	53.84	33.52	11.50	10.16
DUBA6-6	3/8	9.52	3/8	9.52	9/16-18	7.11	3/4	19.05	11/16	17.46	16.76	49.78	29.46	57.15	36.83	14.68	11.17
DUBA8-8	1/2	12.70	1/2	12.70	3/4-16	9.90	5/16	23.81	7/8	22.22	22.86	55.62	31.75	65.78	41.91	19.44	12.70
DUBA12-12	3/4	19.05	3/4	19.05	1-1/16-12	15.49	1-3/16	30.16	1-1/8	28.58	24.38	68.83	37.33	78.99	47.49	25.79	16.76
DUBA16-16	1	25.40	1	25.40	1-5/16-12	21.33	1-5/8	41.27	1-1/2	38.10	31.24	80.26	45.21	92.45	57.40	33.73	19.05
DUBA20-20	1-1/4	31.75	1-1/4	31.75	1-5/8-12	27.68	1-7/8	47.63	1-7/8	47.63	41.14	86.37	47.75	108.47	69.85	41.67	19.05
DUBA24-24	1-1/2	38.10	1-1/2	38.10	1-7/8-12	33.90	2-1/4	57.15	2-1/4	57.15	50.03	94.33	49.27	121.51	76.45	49.61	19.05
DUBA32-32	2	50.80	2	50.80	2-1/2-12	45.97	2-3/4	69.85	3	76.20	67.56	114.29	56.38	151.62	93.71	16.27	19.05

Male AN Adapter
DMAA

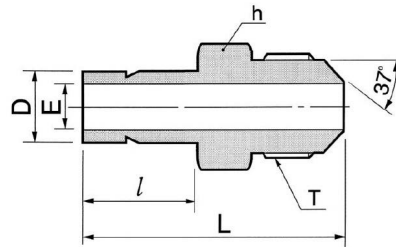
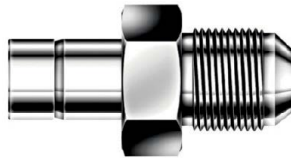

Connects Fractional DK-Lok port to AN flared tube

Part No.	Tube O.D. D		AN Tube Flare Size		Straight Thread T(U)	E Min.	Width across flat h		ℓ	L
	in.	mm	in.	mm			in.	mm		
DMAA4-4	1/4	6.35	1/4	6.35	7/16-20	4.30	1/2	12.70	15.75	37.10
DMAA6-6	3/8	9.52	3/8	9.52	9/16-18	6.80	5/8	15.87	17.50	39.63
DMAA8-6	1/2	12.70	3/8	9.52	9/16-18	6.80	5/8	15.87	23.10	45.70
DMAA8-8	1/2	12.70	1/2	12.70	3/4-16	9.30	13/16	20.64	23.10	48.52
DMAA8-10	1/2	12.70	5/8	15.87	7/8-14	9.30	15/16	23.81	23.10	52.00
DMAA10-10	5/8	15.87	5/8	15.87	7/8-14	12.30	15/16	23.81	27.68	56.13
DMAA12-12	3/4	19.05	3/4	19.05	1-1/16-12	14.70	1-1/8	28.57	24.70	56.13
DMAA16-16	1	25.40	1	25.40	1-5/16-12	20.00	1-3/8	34.92	31.70	65.33

AN Adapter
DAA

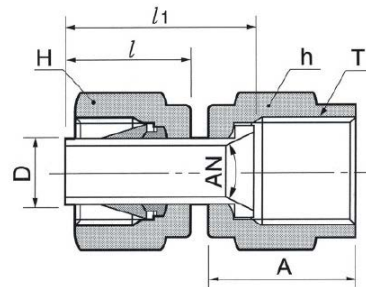

Connects fractional DK-Lok port tube to AN male

Part No.	Tube O.D. D		AN Tube Flare Size		Straight Thread T(U)	Width across flat				A	ℓ	ℓ1
	in.	mm	in.	mm		h		H				
						in.	mm	in.	mm			
DAA2-2	1/8	3.17	1/8	3.17	5/16-24	3/8	9.52	7/16	11.11	13.71	13.46	18.54
DAA2-4	1/8	3.17	1/4	6.35	7/16-20	9/16	14.28	7/16	11.11	15.74	13.46	19.05
DAA4-4	1/4	6.35	1/4	6.35	7/16-20	9/16	14.28	9/16	14.28	15.74	15.74	21.33
DAA6-6	3/8	9.52	3/8	9.52	9/16-18	11/16	17.46	11/16	17.46	18.28	17.52	24.89
DAA8-8	1/2	12.70	1/2	12.70	3/4-16	7/8	22.22	7/8	22.22	21.59	23.11	31.75

AN adapter is useful to connects DK-Lok port to SAE JIC 514 37 male Fitting.

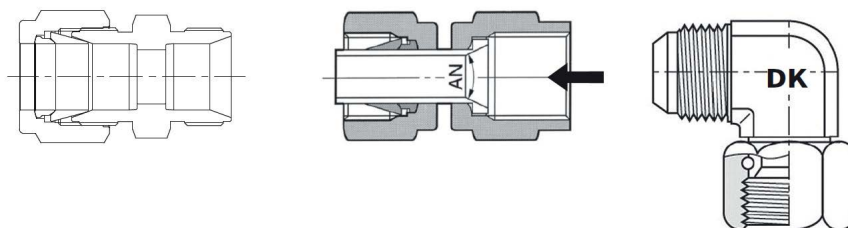

O-Seal Straight Thread Connector (Previously DCOS-U)

DMC-UO

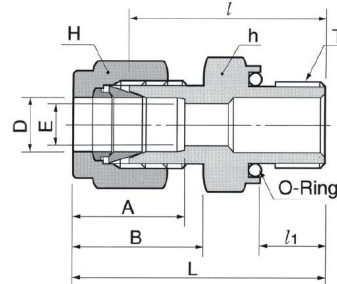

Connects Fractional tube to Female Straight thread

Part No.	Tube O.D. D		Straight Thread T(U)	E Min.	Width across flat				A	B	ℓ	ℓ1	L	O-Ring Uniform Size Number
	in.	mm			h		H							
					in.	mm	in.	mm						
DMC2-2UO	1/8	3.17	5/16-24	2.28	9/16	14.28	7/16	11.11	12.70	15.24	26.16	8.63	32.76	-011
DMC3-3UO	3/16	4.76	3/8-24	3.04	5/8	15.87	1/2	12.70	13.71	16.00	27.68	9.65	34.29	-012
DMC4-4UO	1/4	6.35	7/16-20	4.82	3/4	19.05	9/16	14.28	15.24	17.78	30.98	10.41	38.35	-013
DMC5-5UO	5/16	7.93	1/2-20	6.35	7/8	22.22	5/8	15.87	16.25	18.54	33.27	11.17	40.64	-112
DMC6-6UO	3/8	9.52	9/16-18	7.11	15/16	23.81	11/16	17.46	16.76	19.30	35.05	11.93	42.41	-113
DMC8-8UO	1/2	12.70	3/4-16	10.41	1-1/8	28.57	7/8	22.22	22.86	21.84	35.81	11.93	45.97	-116
DMC12-12UO	3/4	19.05	1-1/16-12	15.74	1-1/2	38.10	1-1/8	28.58	24.38	21.84	42.16	14.22	52.32	-121
DMC16-16UO	1	25.40	1-5/16-12	22.35	1-3/4	44.45	1-1/2	38.10	31.24	26.41	45.97	14.22	58.16	-125

O-Seal Pipe Thread Connector (Previously DCOP)

DMC-NO

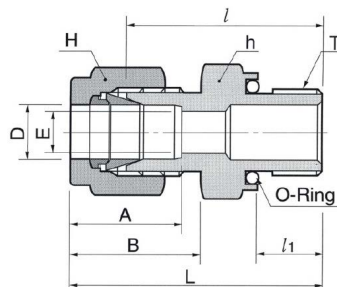

Connects Fractional tube to Female NPT thread

Part No.	Tube O.D. D		T *(NPT)	E Min.	Width across flat				A	B	ℓ	ℓ1	L	O-Ring Uniform Size Number
	in.	mm			h		H							
					in.	mm	in.	mm						
DMC2-2NO	1/8	3.17	1/8	2.28	3/4	19.05	7/16	11.11	12.70	15.24	26.16	7.11	32.76	-013
DMC4-2NO	1/4	6.35	1/8	4.82	3/4	19.05	9/16	14.28	15.24	17.78	27.68	7.11	35.05	-013
DMC4-4NO	1/4	6.35	1/4	4.82	15/16	23.81	9/16	14.28	15.24	17.78	30.98	9.65	38.35	-113
DMC6-4NO	3/8	9.52	1/4	7.11	15/16	23.81	11/16	17.46	16.76	19.30	32.51	9.65	39.87	-113
DMC6-6NO	3/8	9.52	3/8	7.11	1-1/8	28.58	11/16	17.46	16.76	19.30	34.03	10.41	41.40	-116
DMC6-8NO	3/8	9.52	1/2	7.11	1-5/16	33.33	11/16	17.46	16.76	19.30	39.62	13.46	46.99	-118
DMC8-8NO	1/2	12.70	1/2	10.41	1-5/16	33.33	7/8	22.22	22.86	21.84	39.62	13.46	49.78	-118

Installation Instructions

O-seal Connectors

1. Lubricate O-ring with a lubricant compatible with the O-ring material and the system fluid.
2. Fingertighten the O-seal connector into the female port.
3. Hand-tighten until the O-ring squeezing on the face of the female port is felt.
4. Tighten slightly further with a wrench to completely compress the O-ring
 - Keep the O-seal body still during connecting or disconnecting.

Non-Positionable SAE Male Connector

DMCS-U

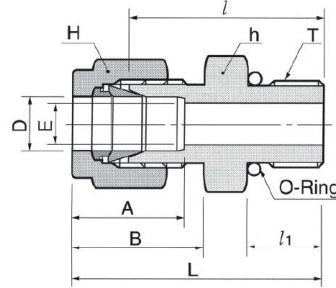

Connects fractional tubes

Part No.	Tube O.D. D		Straight-Thread T(U)	E Min.	Width across flat				A	B	ℓ	ℓ1	L	O-Ring Uniform Size Number
	in.	mm			h		H							
					in.	mm	in.	mm						
DMCS2-2U	1/8	3.17	5/16-24	2.28	7/16	11.11	7/16	11.11	12.70	15.24	23.26	7.62	29.97	-902
DMCS4-4U	1/4	6.35	7/16-20	4.82	9/16	14.28	9/16	14.28	15.24	17.78	26.67	9.14	34.03	-904
DMCS4-6U	1/4	6.35	9/16-18	4.82	11/16	17.46	9/16	14.28	15.24	17.78	28.19	9.90	35.56	-906
DMCS4-8U	1/4	6.35	3/4-16	4.82	7/8	22.22	9/16	14.28	15.24	17.78	30.22	11.17	37.59	-908
DMCS4-10U	1/4	6.35	7/8-14	4.82	1	25.40	9/16	14.28	15.24	17.78	33.27	12.70	40.64	-910
DMCS5-5U	5/16	7.93	1/2-20	5.84	5/8	15.87	5/8	15.87	16.25	18.54	27.43	9.14	34.79	-905
DMCS6-4U	3/8	9.52	7/16-20	5.08	5/8	15.87	11/16	17.46	16.76	19.30	28.19	9.14	35.56	-904
DMCS6-6U	3/8	9.52	9/16-18	7.11	11/16	17.46	11/16	17.46	16.76	19.30	29.71	9.90	37.08	-906
DMCS6-8U	3/8	9.52	3/4-16	7.11	7/8	22.22	11/16	17.46	16.76	19.30	31.75	11.17	39.11	-908
DMCS6-10U	3/8	9.52	7/8-14	7.11	1	25.40	11/16	17.46	16.76	19.30	34.79	12.70	42.16	-910
DMCS8-6U	1/2	12.70	9/16-18	7.11	13/16	20.64	7/8	22.22	22.86	21.84	28.95	9.90	39.11	-906
DMCS8-8U	1/2	12.70	3/4-16	10.41	7/8	22.22	7/8	22.22	22.86	21.84	31.75	11.17	41.91	-908
DMCS8-10U	1/2	12.70	7/8-14	10.41	1	25.40	7/8	22.22	22.86	21.84	34.79	12.70	44.95	-910
DMCS8-12U	1/2	12.70	1-1/16-12	10.41	1-1/4	31.75	7/8	22.22	22.86	21.84	38.86	14.98	49.02	-912
DMCS10-8U	5/8	15.87	3/4-16	10.66	15/16	23.81	1	25.40	24.38	21.84	31.75	11.17	41.91	-908
DMCS10-10U	5/8	15.87	7/8-14	12.70	1	25.40	1	25.40	24.38	21.84	35.05	12.70	45.21	-910
DMCS12-8U	3/4	19.05	3/4-16	10.66	1-1/16	26.98	1-1/8	28.57	24.38	21.84	35.81	11.17	45.97	-908
DMCS12-12U	3/4	19.05	1-1/16-12	15.74	1-1/4	31.75	1-1/8	28.57	24.38	21.84	38.86	14.98	49.02	-912
DMCS14-14U	7/8	22.22	1-3/16-12	18.28	1-3/8	34.92	1-1/4	31.75	25.90	21.84	38.86	14.98	49.02	-914
DMCS16-12U	1	25.40	1-1/16-12	16.76	1-3/8	34.92	1-1/2	38.10	31.24	26.41	41.14	14.98	53.34	-912
DMCS16-16U	1	25.40	1-5/16-12	22.35	1-1/2	38.10	1-1/2	38.10	31.24	26.41	42.16	14.98	54.35	-916
DMCS20-20U	1-1/4	31.75	1-5/8-12	27.68	1-7/8	47.63	1-7/8	47.63	41.14	38.86	46.22	14.98	68.32	-920
DMCS24-24U	1-1/2	38.10	1-7/8-12	33.90	2-1/8	53.98	2-1/4	57.15	50.03	45.21	50.54	14.98	77.72	-924
DMCS32-32U	2	50.80	2-1/2-12	45.97	2-3/4	69.85	3	76.20	67.56	62.73	64.26	14.98	101.60	-932

Connects metric tube to SAE straight thread boss

Part No.	Tube O.D. D	Straight Thread T(U)	E Min.	Width across flat		A	B	ℓ	ℓ1	L	O-Ring Uniform Size Number
				h	H						
DMCS6M-6U	6	9/16-18	4.8	18	14	15.3	17.7	28.2	9.90	36.5	-906
DMCS10M-6U	10	9/16-18	7.9	18	19	17.2	19.5	29.7	9.90	37.3	-906
DMCS10M-8U	10	3/4-16	7.9	22	19	17.2	19.5	31.8	11.17	39.4	-908
DMCS12M-4U	12	7/16-20	5.2	22	22	22.8	22.0	28.2	9.14	38.3	-904
DMCS12M-6U	12	9/16-18	7.5	22	22	22.8	22.0	29.0	9.90	39.1	-906

Positionable SAE Male Elbow

DLS-UP

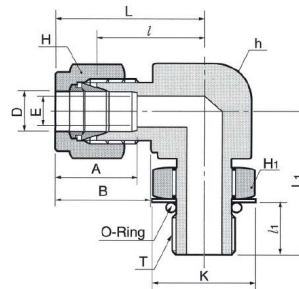

Connects fractional tube to SAE straight thread boss

Part No.	Tube O.D. D		Straight Thread T(U)	E Min.	Width across flat						A	B	ℓ	ℓ1	L	L1	K	O-Ring Uniform Size Number
	in.	mm			h		H		H1									
					in.	mm	in.	mm	in.	mm								
DLS4-4UP	1/4	6.35	7/16-20	4.82	1/2	12.70	9/16	14.28	9/16	14.28	15.24	17.78	21.08	9.90	28.44	28.44	16.51	-904
DLS5-5UP	5/16	7.93	1/2-20	5.84	9/16	14.28	5/8	15.87	5/8	15.87	16.25	18.54	22.86	9.90	30.22	29.46	18.28	-905
DLS6-6UP	3/8	9.52	9/16-18	7.11	5/8	15.87	11/16	17.46	11/16	17.46	16.76	19.30	24.63	11.17	32.00	32.25	20.06	-906
DLS6-8UP	3/8	9.52	3/4-16	7.11	13/16	20.64	11/16	17.46	7/8	22.22	16.76	19.30	27.43	12.70	34.79	37.84	25.65	-908
DLS8-8UP	1/2	12.70	3/4-16	10.41	13/16	20.64	7/8	22.22	7/8	22.22	22.86	21.84	27.43	12.70	37.59	37.84	25.65	-908
DLS10-10UP	5/8	15.87	7/8-14	12.70	1	25.40	1	25.40	1	25.40	24.38	21.84	29.46	14.22	39.62	43.43	29.46	-910
DLS12-12UP	3/4	19.05	1-1/16-12	15.74	1-1/16	26.98	1-1/8	28.57	1-1/4	31.75	24.38	21.84	31.24	16.76	41.40	48.76	36.57	-912
DLS14-14UP	7/8	22.22	1-3/16-12	18.28	1-1/4	31.75	1-1/4	31.75	1-3/8	34.92	25.90	21.84	33.02	16.76	43.18	50.54	40.38	-914
DLS16-16UP	1	25.40	1-5/16-12	22.35	1-3/8	34.92	1-1/2	38.10	1-1/2	38.10	31.24	26.41	38.35	16.76	50.54	53.59	43.94	-916
DLS20-20UP	1-1/4	31.75	1-5/8-12	27.68	1-11/16	42.76	1-7/8	47.63	1-7/8	47.63	41.14	38.86	45.72	16.76	67.81	58.16	54.86	-920
DLS24-24UP	1-1/2	38.10	1-7/8-12	33.90	2	50.80	2-1/4	57.15	2-1/8	53.98	50.03	45.21	50.80	16.76	77.97	60.45	62.23	-924
DLS32-32UP	2	50.80	2-1/2-12	45.97	2-3/4	69.85	3	76.20	2-3/4	69.85	67.56	62.73	69.85	16.76	107.18	71.62	80.26	-932

Installation Instructions

SAE and ISO parallel thread Fittings

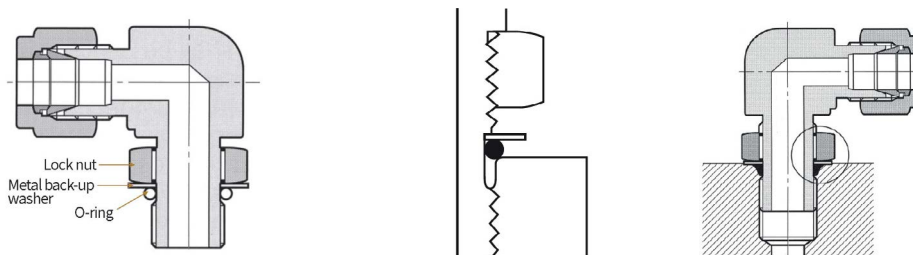

1. Lubricate O-ring with a lubricant compatible with the O-ring material and the system fluid.
2. Back the locknut out.
3. Finger-tighten the fitting into the straight thread boss until the metal backup washer contacts the face of the boss.
4. Position the fitting by backing it out until the fitting end is positioned in the desired direction.
 - No more than one turn backing out.
5. Hold the fitting in the direction and wrench-tighten the locknut until the washer contacts the face of the boss.

Positionable 45° SAE Male Elbow(Previously DLBS-U)

DLBS-UP

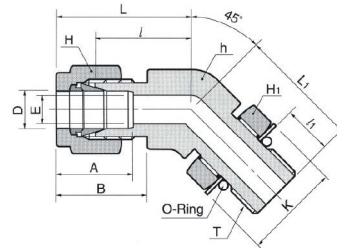

Connects fractional tube to SAE straight thread boss

Part No.	Tube O.D. D		Straight Thread T(U)	E Min.	Width across flat						A	B	ℓ	ℓ1	L	L1	K	O-Ring Uniform Size Number
	in.	mm			h		H		H1									
					in.	mm	in.	mm	in.	mm								
DLBS4-4UP	1/4	6.35	7/16-20	4.82	1/2	12.70	9/16	14.28	9/16	14.28	15.24	17.78	18.28	9.90	25.65	25.65	16.51	-904
DLBS6-6UP	3/8	9.52	9/16-18	7.11	5/8	15.87	11/16	17.46	11/16	17.46	16.76	19.30	20.57	11.17	27.94	28.19	20.06	-906
DLBS8-8UP	1/2	12.70	3/4-16	10.41	13/16	20.64	7/8	22.22	7/8	22.22	22.86	21.84	21.84	12.70	32.00	32.25	25.65	-908
DLBS12-12UP	3/4	19.05	1-1/16-12	15.74	1-1/8	28.58	1-1/8	28.58	1-1/4	31.75	24.38	21.84	29.71	16.76	39.87	47.24	36.57	-912
DLBS16-16UP	1	25.40	1-5/16-12	22.35	1-3/8	34.92	1-1/2	38.10	1-1/2	38.10	31.24	26.41	35.30	16.76	47.49	50.54	43.94	-916

Positionable SAE Male Run Tee(Previously DTRS-U)

DTRS-UP

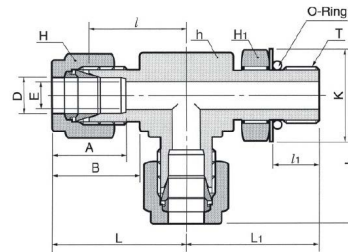

Connects fractional tube to SAE straight thread boss

Part No.	Tube O.D. D		Straight Thread T(U)	E Min.	Width across flat						A	B	ℓ	ℓ1	L	L1	K	O-Ring Uniform Size Number
	in.	mm			h		H		H1									
					in.	mm	in.	mm	in.	mm								
DTRS4-4UP	1/4	6.35	7/16-20	4.82	1/2	12.70	9/16	14.28	9/16	14.28	15.24	17.78	21.08	9.90	28.44	28.44	16.51	-904
DTRS6-6UP	3/8	9.52	9/16-18	7.11	5/8	15.87	11/16	17.46	11/16	17.46	16.76	19.30	24.63	11.17	32.00	32.25	20.06	-906
DTRS8-8UP	1/2	12.70	3/4-16	10.41	13/16	20.64	7/8	22.22	7/8	22.22	22.86	21.84	27.43	12.70	37.59	37.84	25.65	-908
DTRS12-12UP	3/4	19.05	1-1/16-12	15.74	1-1/8	26.98	1-1/8	28.58	1-1/4	31.75	24.38	21.84	31.24	16.76	41.40	48.76	36.57	-912
DTRS16-16UP	1	25.40	1-5/16-12	22.35	1-3/8	34.92	1-1/2	38.10	1-1/2	38.10	31.24	26.41	38.35	16.76	50.54	50.54	43.94	-916
DTRS20-20UP	1-1/4	31.75	1-5/8-12	27.68	1-11/16	42.86	1-7/8	47.63	1-7/8	47.63	41.14	38.86	45.72	16.76	67.81	58.16	54.86	-920
DTRS24-24UP	1-1/2	38.10	1-7/8-12	33.90	2	50.80	2-1/4	57.15	2-1/8	53.98	50.03	45.21	50.80	16.76	77.97	60.45	62.23	-924
DTRS32-32UP	2	50.80	2-1/2-12	45.97	2-3/4	69.85	3	76.20	2-3/4	69.85	67.56	62.73	69.85	16.76	107.18	71.62	80.26	-932

Positionable SAE Male Branch Tee(Previously DTBS-U)

DTBS-UP

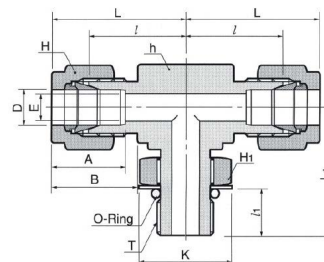

Connects fractional tube to SAE straight thread boss

Part No.	Tube O.D. D		Straight Thread T(U)	E Min.	Width across flat						A	B	ℓ	ℓ1	L	L1	K	O-Ring Uniform Size Number
	in.	mm			h		H		H1									
					in.	mm	in.	mm	in.	mm								
DTBS 4-4UP	1/4	6.35	7/16-20	4.82	1/2	12.70	9/16	14.28	9/16	14.28	15.24	17.78	21.08	9.90	28.44	28.44	16.51	-904
DTBS 6-6UP	3/8	9.52	9/16-18	7.11	5/8	15.87	11/16	17.46	11/16	17.46	16.76	19.30	24.63	11.17	32.00	32.25	20.06	-906
DTBS 8-8UP	1/2	12.70	3/4-16	10.41	13/16	20.64	7/8	22.22	7/8	22.22	22.86	21.84	27.43	12.70	37.59	37.84	25.65	-908
DTBS 12-12UP	3/4	19.05	1-1/16-12	15.74	1-1/8	26.98	1-1/8	28.58	1-1/4	31.75	24.38	21.84	31.24	16.76	41.40	48.76	36.57	-912
DTBS 16-16UP	1	25.40	1-5/16-12	22.35	1-3/8	34.92	1-1/2	38.10	1-1/2	38.10	31.24	26.41	38.35	16.76	50.54	53.59	43.94	-916
DTBS 20-20UP	1-1/4	31.75	1-5/8-12	27.68	1-11/16	42.86	1-7/8	47.63	1-7/8	47.63	41.14	38.86	45.72	16.76	67.81	58.16	54.86	-920
DTBS 24-24UP	1-1/2	38.10	1-7/8-12	33.90	2	50.80	2-1/4	57.15	2-1/8	53.98	50.03	45.21	50.80	16.76	77.97	60.45	62.23	-924
DTBS 32-32UP	2	50.80	2-1/2-12	45.97	2-3/4	69.85	3	76.20	2-3/4	69.85	67.56	62.73	69.85	16.76	107.18	71.62	80.26	-932

Positionable Male Elbow ISO Parallel thread

DLM-GP

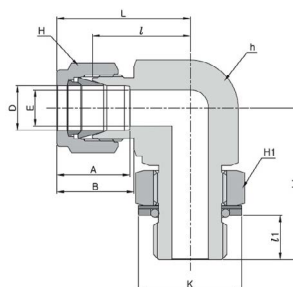

Connects fractional tube to ISO parallel thread

Part No.	Tube O.D. D		T G(PF)	E Min.	Width across flat						A	B	ℓ	ℓ1	L	L1	K	O-Ring Uniform Size Number
	in.	mm			h		H		H1									
					in.	mm	in.	mm	in.	mm								
DLM4-2GP	1/4	6.35	1/8	4.06	1/2	12.70	9/16	14.28	9/16	14.28	15.24	17.78	19.6	8.12	26.92	26.42	15.20	P8
DLM4-4GP	1/4	6.35	1/4	4.82	5/8	15.87	11/16	17.46	3/4	19.05	15.24	17.78	21.6	9.14	28.95	32.30	20.30	-111
DLM6-4GP	3/8	9.52	1/4	5.84	5/8	15.87	11/16	17.46	3/4	19.05	16.76	19.30	23.1	9.14	30.48	32.30	20.30	-111
DLM6-6GP	3/8	9.52	3/8	7.11	13/16	20.64	11/16	17.46	3/4	19.05	16.76	19.30	25.9	9.39	33.27	37.10	24.40	-113
DLM8-4GP	1/2	12.70	1/4	5.84	13/16	20.64	7/8	22.22	7/8	22.22	22.86	21.84	25.9	9.14	36.06	35.10	20.30	-111
DLM8-6GP	1/2	12.70	3/8	7.87	13/16	20.64	7/8	22.22	7/8	22.22	22.86	21.84	25.9	9.39	36.06	37.10	24.40	-113
DLM8-8GP	1/2	12.70	1/2	10.41	15/16	23.81	7/8	22.22	1-1/16	26.98	22.86	21.84	27.9	12.95	38.10	43.40	29.50	P18
DLM12-8GP	3/4	19.05	1/2	11.93	1-1/16	26.98	1-1/8	28.57	1-1/16	26.98	24.38	21.84	29.7	12.95	39.87	45.21	29.50	P18
DLM12-12GP	3/4	19.05	3/4	15.74	1-1/16	26.98	1-1/8	28.57	1-3/8	34.92	24.38	21.84	29.7	12.95	39.87	48.77	36.30	-119
DLM16-16GP	1	25.40	1	19.81	1-3/8	34.92	1-1/2	38.10	1-5/8	41.28	31.24	26.41	36.8	13.97	49.02	53.60	46.20	-217

Connects metric tube to ISO parallel thread

Part No.	Tube O.D. D	T G(PF)	E Min.	Width across flat			A	B	ℓ	ℓ1	L	L1	K	O-Ring Uniform Size Number
				h	H	H1								
DLM6M-2GP	6	1/8	4.0	12.7	14	14.28	15.3	17.7	19.6	8.1	27.0	26.4	15.20	P8
DLM6M-4GP	6	1/4	4.8	15.8	14	19.05	15.3	17.7	21.6	9.1	29.0	32.3	20.30	-111
DLM6M-6GP	6	3/8	4.8	20.6	14	22.22	15.3	17.7	24.4	9.4	31.8	37.1	24.40	-113
DLM8M-2GP	8	1/8	4.0	14.2	16	14.28	16.2	18.6	21.3	8.1	28.8	27.4	15.20	P8
DLM8M-4GP	8	1/4	5.9	15.8	16	19.05	16.2	18.6	22.4	9.1	29.9	32.2	20.30	-111
DLM10M-4GP	10	1/4	5.9	20.6	19	19.05	17.2	19.5	25.9	9.1	33.5	35.0	20.30	-113
DLM10M-6GP	10	3/8	7.9	20.6	19	22.22	17.2	19.5	25.9	9.4	33.5	37.1	24.40	-111
DLM12M-4GP	12	1/4	5.9	20.6	22	19.05	22.8	22.0	25.9	9.1	36.0	35.0	20.30	-113
DLM12M-6GP	12	3/8	7.9	20.6	22	22.22	22.8	22.0	25.9	9.4	36.0	37.1	24.40	-113
DLM12M-8GP	12	1/2	9.5	23.8	22	26.98	22.8	22.0	27.9	13.0	38.0	43.4	29.50	P18

Male Pipe Weld Connector DCW

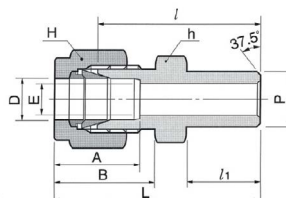

Connects fractional tube to pipe

Part No.	Tube O.D. D		Male Pipe Size P		E Min.	Width across flat				A	B	ℓ	ℓ1	L
	in.	mm	Nom.	O.D.		h		H						
						in.	mm	in.	mm					
DCW2-2P	1/8	3.17	1/8	10.29	2.28	7/16	11.11	7/16	11.11	12.70	15.24	23.87	9.65	31.24
DCW3-2P	3/16	4.76	1/8	10.29	3.04	7/16	11.11	1/2	12.70	13.71	16.00	24.63	9.65	31.24
DCW4-2P	1/4	6.35	1/8	10.29	4.82	1/2	12.70	9/16	14.28	15.24	17.78	25.40	9.65	32.76
DCW4-4P	1/4	6.35	1/4	13.72	4.82	9/16	14.28	9/16	14.28	15.24	17.78	30.48	14.22	37.84
DCW5-2P	5/16	7.93	1/8	10.29	5.08	9/16	14.28	5/8	15.87	16.25	18.54	26.67	9.65	34.03
DCW5-4P	5/16	7.93	1/4	13.72	6.35	9/16	14.28	5/8	15.87	16.25	18.54	31.24	14.22	38.60
DCW6-4P	3/8	9.52	1/4	13.72	7.11	5/8	15.87	11/16	17.46	16.76	19.30	32.51	14.22	39.87
DCW6-6P	3/8	9.52	3/8	17.15	7.11	11/16	17.46	11/16	17.46	16.76	19.30	32.51	14.22	39.87
DCW6-8P	3/8	9.52	1/2	21.34	7.11	7/8	22.22	11/16	17.46	16.76	19.30	38.86	11.05	43.23
DCW8-6P	1/2	12.70	3/8	17.15	10.41	13/16	20.64	7/8	22.22	22.86	21.84	33.27	14.22	43.43
DCW8-8P	1/2	12.70	1/2	21.34	10.41	7/8	22.22	7/8	22.22	22.86	21.84	38.86	19.05	49.02
DCW8-12P	1/2	12.70	3/4	26.67	10.41	1-1/16	26.98	7/8	22.22	22.86	21.84	40.38	19.05	50.54
DCW10-8P	5/8	15.87	1/2	21.34	12.70	15/16	23.81	1	25.40	24.38	21.84	38.86	19.05	49.02
DCW12-12P	3/4	19.05	3/4	26.67	15.74	1-1/16	26.98	1-1/8	28.58	24.38	21.84	40.38	19.05	50.54
DCW16-16P	1	25.40	1	33.40	22.35	1-3/8	34.92	1-1/2	38.10	31.24	26.41	50.03	23.87	62.23
DCW20-20P	1-1/4	31.75	1-1/4	42.16	27.68	1-3/4	44.45	2	50.80	41.14	38.86	55.11	23.87	77.21
DCW24-24P	1-1/2	38.10	1-1/2	48.26	34.03	2-1/8	53.98	2-1/4	57.15	50.03	45.21	61.72	26.16	88.90
DCW32-32P	2	50.80	2	60.33	47.75	2-3/4	69.85	3	76.20	67.56	62.73	76.20	26.92	113.53

Connects metric tube to pipe

Part No.	Tube O.D. D	Male Pipe Size P		E Min.	Width across flat		A	B	ℓ	ℓ1	L2
		Nom.	O.D.		h						
					h	H					
DCW3M-2P	3	1/8	10.29	2.4	12	12	12.9	15.3	23.1	9.7	29.7
DCW4M-2P	4	1/8	10.29	2.4	12	12	13.7	16.1	24.1	9.7	30.7
DCW6M-2P	6	1/8	10.29	4.8	14	14	15.3	17.7	25.4	9.7	32.8
DCW6M-4P	6	1/4	13.72	4.8	14	14	15.3	17.7	30.2	14.2	37.6
DCW8M-2P	8	1/8	10.29	5.1	15	16	16.2	18.6	26.7	9.7	34.2
DCW8M-4P	8	1/4	13.72	6.4	15	16	16.2	18.6	31.2	14.2	38.7
DCW8M-8P	8	1/2	21.34	6.4	22	16	16.2	18.6	37.3	19.0	44.8
DCW10M-4P	10	1/4	13.72	7.1	18	19	17.2	19.5	33.3	14.2	40.9
DCW10M-6P	10	3/8	17.15	7.9	18	19	17.2	19.5	32.5	14.2	40.1
DCW10M-8P	10	1/2	21.34	7.9	22	19	17.2	19.5	38.1	19.0	45.7
DCW12M-4P	12	1/4	13.72	7.1	22	22	22.8	22.0	33.3	14.2	43.4
DCW12M-6P	12	3/8	17.15	9.5	22	22	22.8	22.0	33.3	14.2	43.4
DCW12M-8P	12	1/2	21.34	9.5	22	22	22.8	22.0	38.1	19.0	48.2
DCW14M-6P	14	3/8	17.15	10.3	24	25	24.4	22.0	34.0	14.2	44.1
DCW15M-8P	15	1/2	21.34	11.9	24	25	24.4	22.0	38.9	19.0	49.0
DCW16M-8P	16	1/2	21.34	12.7	24	25	24.4	22.0	38.9	19.0	49.0
DCW18M-8P	18	1/2	21.34	13.5	27	30	24.4	22.0	40.4	19.0	50.5
DCW32M-20P	32	1-1/4	42.16	28.6	46	50	42.0	41.6	56.6	23.9	79.6
DCW38M-24P	38	1-1/2	48.26	33.7	55	60	49.4	47.9	64.0	26.2	91.6

Male Pipe Weld Elbow
DLW

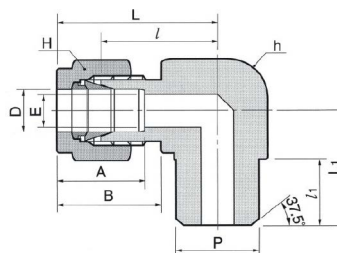

Connects fractional tubes

Part No.	Tube O.D. D		Male Pipe Size P		E Min.	Width across flat				A	B	ℓ	ℓ1	L	L1
	in.	mm	Nom.	O.D.		h		H							
						in.	mm	in.	mm						
DLW2-2P	1/8	3.17	1/8	10.29	4.82	1/2	12.70	9/16	14.28	15.24	17.78	19.55	9.65	26.92	18.79
DLW4-4P	1/4	6.35	1/4	13.72	4.82	1/2	12.70	9/16	14.28	15.24	17.78	19.55	14.22	26.92	23.36
DLW6-4P	3/8	9.52	1/4	13.72	7.11	5/8	15.87	11/16	17.46	16.76	19.30	23.11	14.22	30.48	25.40
DLW8-8P	1/2	12.70	1/2	21.34	10.41	13/16	20.64	7/8	22.22	22.86	21.84	25.90	19.05	36.06	33.02
DLW12-12P	3/4	19.05	3/4	26.67	15.74	1-1/16	26.98	1-1/8	28.58	24.38	21.84	29.71	19.05	39.87	36.83

Tube Socket Weld Connector
DCSW

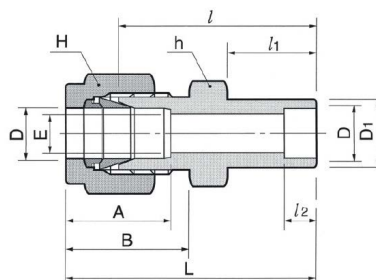

Connects fractional tubes

Part No.	Tube O.D. D		E Min.	D1	Width across flat				A	B	ℓ	ℓ1	L	L1
	in.	mm			h		H							
					in.	mm	in.	mm						
DCSW2-2	1/8	3.17	2.28	7.87	7/16	11.11	7/16	11.11	12.70	15.24	22.35	8.63	6.35	28.95
DCSW4-4	1/4	6.35	4.82	11.17	1/2	12.70	9/16	14.28	15.24	17.78	26.16	10.41	7.87	33.52
DCSW6-6	3/8	9.52	7.11	15.74	5/8	15.87	11/16	17.46	16.76	19.30	30.22	11.93	9.65	37.59
DCSW8-8	1/2	12.70	10.41	19.05	13/16	20.64	7/8	22.22	22.86	21.84	30.98	11.93	12.70	41.14
DCSW12-12	3/4	19.05	15.74	26.67	1-1/16	26.98	1-1/8	28.58	24.38	21.84	33.27	11.93	14.22	43.43
DCSW16-16	1	25.40	22.35	33.27	1-3/8	34.92	1-1/2	38.10	31.24	26.41	40.38	14.22	19.05	52.57

DK-Lok Welding Information

DK-Lok weld ends are constructed to SCH. 80 or greater

- Remove the nut and ferrules from the DK-Lok port.
 - This protects the nut and ferrules from weld heat.
- Cover the DK-Lok port threads with a protective device such as DK-Lok Plug (DP).
 - This protects threads and sealing surface on the DK-Lok port.
 - Finger-tighten the DP to use it many times.
- Tack weld at four positions 90 degree apart.
 - This holds the fitting in alignment and concentricity.
- Complete the welding.
- Remove the protective device and replace the nut and ferrules.

Tube Socket Weld Elbow

DLSW

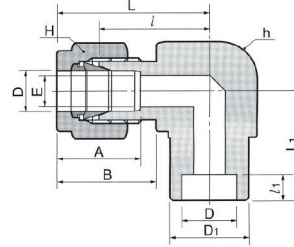

Connects fractional tubes

Part No.	Tube O.D. D		E Min.	D1	Width across flat				A	B	ℓ	ℓ1	L1	L2
	in.	mm			h		H							
					in.	mm	in.	mm						
DLSW4-4	1/4	6.35	4.82	12.70	1/2	12.70	9/16	14.28	15.24	17.78	19.55	7.87	26.92	19.55
DLSW6-6	3/8	9.52	7.11	15.74	5/8	15.87	11/16	17.46	16.76	19.30	23.11	9.65	30.48	23.11
DLSW8-8	1/2	12.70	10.41	20.57	13/16	20.64	7/8	22.22	22.86	21.84	25.90	12.70	36.06	25.90
DLSW12-12	3/4	19.05	15.74	26.92	1-1/16	26.98	1-1/8	28.58	24.38	21.84	29.71	14.22	39.87	29.71
DLSW16-16	1	25.40	22.35	35.05	1-3/8	34.93	1-1/2	38.10	31.24	26.41	36.83	19.05	49.02	36.83

Welding Bulkhead Union

DBUW

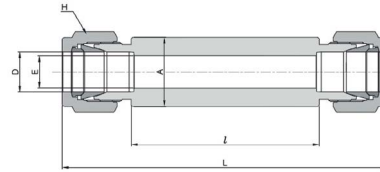

Connects fractional tubes

Part No.	Tube O.D. D		E Min.	A Diameter	Width across flat H		ℓ	L
	in.	mm			in.	mm		
DBUW-4	1/4	6.35	4.80	16.0	9/16	14.28	80.00	115.40
DBUW-6	3/8	9.52	7.10	19.0	11/16	17.46	80.00	118.40
DBUW-8	1/2	12.70	10.41	22.0	7/8	22.22	80.00	124.00

Plug

DP

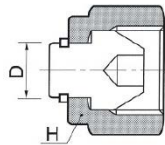

Plugs metric DK-Lok Port

Part No.	Tube O.D. D	Width across flat H	Part No.	Tube O.D. D	Width across flat H
DP-2M	2	12	DP-16M	16	25
DP-3M	3	12	DP-18M	18	30
DP-4M	4	12	DP-20M	20	32
DP-6M	6	14	DP-22M	22	32
DP-8M	8	16	DP-25M	25	38
DP-10M	10	19	DP-28M	28	46
DP-12M	12	22	DP-32M	32	50
DP-15M	15	25	DP-38M	38	60

Plugs fractional DK-Lok port

Part No.	Tube O.D. D		Width across flat H	
	in.	mm	in.	mm
DP-1	1/16	1.59	5/16	7.93
DP-2	1/8	3.17	7/16	11.11
DP-3	3/16	4.76	1/2	12.70
DP-4	1/4	6.35	9/16	14.28
DP-5	5/16	7.93	5/8	15.87
DP-6	3/8	9.52	11/16	17.46
DP-8	1/2	12.70	7/8	22.22
DP-10	5/8	15.87	1	25.40
DP-12	3/4	19.05	1-1/8	28.58
DP-14	7/8	22.22	1-1/4	31.75
DP-16	1	25.40	1-1/2	38.10
DP-20	1-1/4	31.75	1-7/8	47.63
DP-24	1-1/2	38.10	2-1/4	57.15
DP-32	2	50.80	3	76.20

Installation Instructions

Plug is for plugging un-used DK-Lok port.

1. Remove the nut and ferrules from the DK-Lok fitting body.
2. Finger-tighten the plug.
3. Tighten the plug 1/4 turn beyond the finger-tight position, keeping the fitting body steady with a backup wrench.
 - Do not tighten 1 1/4 turns as this has machined ferrule not the standard ferrules.
 - Tighten 1/8 turn for 1/16, 1/8, and 3/16 in.; 2, 3, and 4 mm Tube Fittings.

Cap
DC

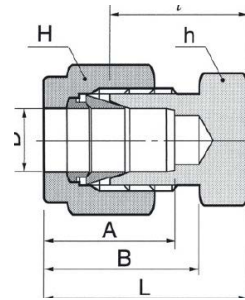

Caps fractional tube end

Part No.	Tube O.D. D		Width across flat				A	B	ℓ	L
	in.	mm	h		H					
			in.	mm	in.	mm				
DC-1	1/16	1.59	5/16	7.93	5/16	7.93	8.63	10.92	11.20	14.18
DC-2	1/8	3.17	7/16	11.11	7/16	11.11	12.70	15.24	13.46	20.06
DC-3	3/16	4.76	7/16	11.11	1/2	12.70	13.71	16.00	14.73	21.33
DC-4	1/4	6.35	1/2	12.70	9/16	14.28	15.24	17.78	16.00	23.26
DC-5	5/16	7.93	9/16	14.28	5/8	15.87	16.25	18.54	17.01	24.38
DC-6	3/8	9.52	5/8	15.87	11/16	17.46	16.76	19.30	18.28	25.65
DC-8	1/2	12.70	13/16	20.63	7/8	22.22	22.86	21.84	19.05	29.21
DC-10	5/8	15.87	15/16	23.81	1	25.40	24.38	21.84	19.81	29.97
DC-12	3/4	19.05	1-1/16	26.98	1-1/8	28.57	24.38	21.84	21.33	31.49
DC-14	7/8	22.22	1-3/16	30.16	1-1/4	31.75	25.90	21.84	23.87	34.03
DC-16	1	25.40	1-3/8	34.92	1-1/2	38.10	31.24	26.41	26.16	38.35
DC-20	1-1/4	31.75	1-3/4	44.45	1-7/8	47.63	41.14	38.86	31.24	53.34
DC-24	1-1/2	38.10	2-1/8	53.98	2-1/4	57.15	50.15	45.21	37.33	64.51
DC-32	2	50.80	2-3/4	69.85	3	76.20	67.56	62.73	49.27	86.61

Caps metric tube ends

Part No.	Tube O.D. D	Width across flat		A	B	ℓ	L
		h	H				
DC-2M	2	12	12	12.9	15.3	13.5	20.1
DC-3M	3	12	12	12.9	15.3	13.5	20.1
DC-4M	4	12	12	13.7	16.1	14.7	21.3
DC-6M	6	14	14	15.3	17.7	15.7	23.1
DC-8M	8	15	16	16.2	18.6	17.0	24.5
DC-10M	10	18	19	17.2	19.5	19.0	26.6
DC-12M	12	22	22	22.8	22.0	19.0	29.1
DC-15M	15	24	25	24.4	22.0	19.8	29.9
DC-16M	16	24	25	24.4	22.0	19.8	29.9
DC-18M	18	27	30	24.4	22.0	21.3	31.4
DC-20M	20	30	32	26.0	22.0	23.9	34.0
DC-22M	22	30	32	26.0	22.0	23.9	34.0
DC-25M	25	35	38	31.3	26.5	26.2	38.5
DC-28M	28	41	46	36.6	36.6	27.7	48.5
DC-32M	32	46	50	42.0	41.6	32.8	55.8
DC-38M	38	55	60	49.4	47.9	37.8	65.4

Installation Instructions

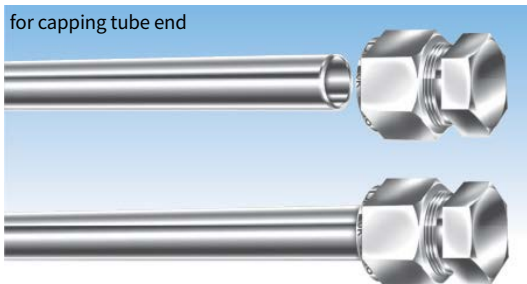

Cap

DK-Lok Cap is for capping tubing end

1. Insert tube end into the cap
 - Make sure tube end bottoms on the shoulder of the cap.
2. Finger-tighten the nut
3. Wrench-tighten the nut 1 1/4 turns beyond the finger tight position, keeping the body steady with a backup wrench.
 - Tightens 3/4 turns for 1/16, 1/8, and 3/16 in.; 2,3, and 4mm fittings.
 - For re-use, see re-assembly instruction

Tube Insert

DI

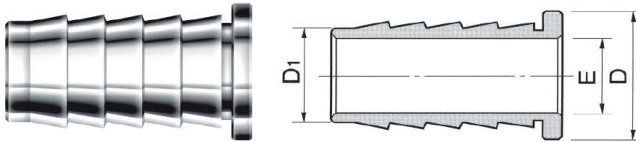

Fractional

Part No.	Plastic Tube				E
	D (Tube OD)		D1 (Tube ID)		
	in.	mm	in.	mm	
DI3-2	3/16	4.76	1/8	3.17	2.28
DI4-2	1/4	6.35	1/8	3.17	2.28
DI4-3	1/4	6.35	3/16	4.76	3.55
DI5-2	5/16	7.93	1/8	3.17	2.28
DI5-3	5/16	7.93	3/16	4.76	3.04
DI5-4	5/16	7.93	1/4	6.35	4.82
DI6-3	3/8	9.52	3/16	4.76	3.04
DI6-4	3/8	9.52	1/4	6.35	4.82
DI8-4	1/2	12.7	1/4	6.35	4.82
DI8-6	1/2	12.7	3/8	9.52	7.87
DI10-6	5/8	15.87	3/8	9.52	7.87
DI10-8	5/8	15.87	1/2	12.70	11.17
DI12-8	3/4	19.05	1/2	12.70	11.17
DI12-10	3/4	19.05	5/8	15.87	14.22
DI16-12	1	25.4	3/4	19.05	17.52

Installation Instructions

Tube Insert

for Nylon or soft Plastic Tubing

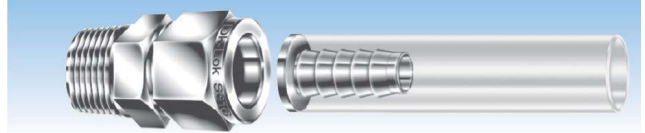

DK-Lok tube insert supports the soft plastic tube internally. This helps the soft tube to connect to DK-Lok port with no collapse.

1. Fully insert the tube insert into the soft plastic tube end. .
 2. Insert the soft tube end into the DK-Lok port.
 3. Finger-tighten the nut.
 4. Tighten the nut 1 1/4 turns with a wrench, keeping the body steady with a backup wrench.
- Tighten 3/4 turn for 3/16 in. fittings.

Metric

Part No.	Plastic Tube		E
	D (Tube OD)	D1 (Tube ID)	
DI6M-4M	6	4	2.8
DI8M-6M	8	6	4.4
DI10M-8M	10	8	6.4
DI12M-8M	12	8	6.4
DI12M-10M	12	10	8.3

Fuse Plug

DFA

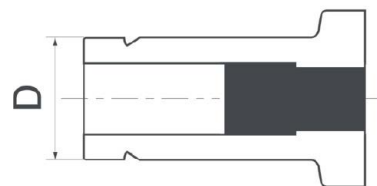

DK-Lok fuse plug is applicable where heat could initiate fire or an explosive chemical reaction. Fuse plug alloy metal melts or yields at the rated temperature. This is designed to use with DK-Lok port 3/8 in. OD.

- Maximum applicable instrument pressure: 10 bar (145 psig)

Connects DK-Lok port 3/8 in. OD

Part No.	Tube O.D. D		Temperature Designator	Nominal Temperature Rating
	in.	mm		
DFA-6-160-S	3/8	9.52	160	160°F (71°C)
DFA-6-201-S	3/8	9.52	201	201°F (94°C)
DFA-6-255-S	3/8	9.52	255	255°F (124°C)
DFA-6-281-S	3/8	9.52	281	281°F (138°C)

Vent Protector
DMD

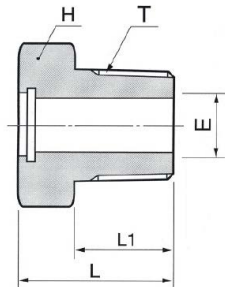
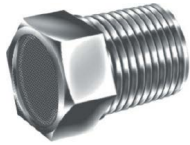

Connects to Female NPT thread

Part No.	T (NPT)	E Min.	H		L	L1
			in.	mm		
DMD-4N	1/4	7.11	9/16	15.87	20.57	14.22
DMD-6N	3/8	10.40	11/16	17.46	20.57	14.22
DMD-8N	1/2	12.70	7/8	23.81	26.92	19.05
DMD-12N	3/4	16.00	1-1/16	26.98	28.70	19.05

Construction with bored-through pipe plug and stainless steel 40 x 40 mesh, 0.010 in. diameter.

DK-Lok vent protector known as bug protector protects foreign particles like insects or debris from entering open ends of instruments or outlet vents.

Calibration Fittings
DPCM

DP Transmitter Calibration fittings

DK-Lok Calibration fitting connects directly to the bleed port of a differential pressure transmitter. This helps simplify the calibration process. Two sizes of threads are available to fit the vent port of Yokogawa/Rosemount, and Honeywell differential pressure transmitters. The conical metal-to-metal sealing face on the straight thread requires no PTFE tape.

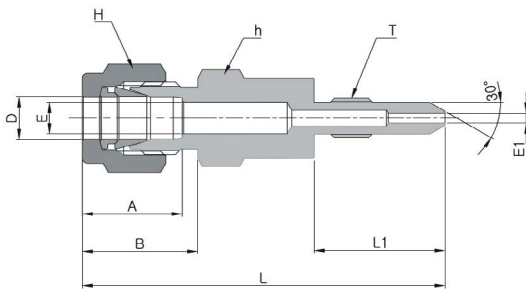

2U thread calibration fitting for Yokogawa/Rosemount DP transmitters

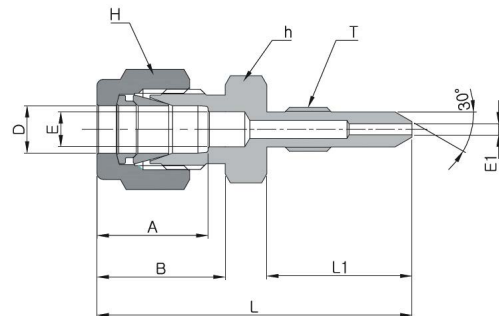

1U thread calibration fitting for Honeywell DP transmitters

Part No.	Tube O.D. D		Straight Thread T(U)	E	E1 Min.	Width across flat				A	B	L	L1
	in.	mm				h		H					
					in.	mm	in.	mm					
DPCM 4-1U-S	1/4	6.35	1/4-28	4.8	1.5	1/2	12.7	9/16	14.28	15.24	17.78	43.08	19.90
DPCM 4-2U-S	1/4	6.35	5/16-24	4.8	1.5	1/2	12.7	9/16	14.28	15.24	17.78	59.23	35.75

Dielectric Fittings DEU

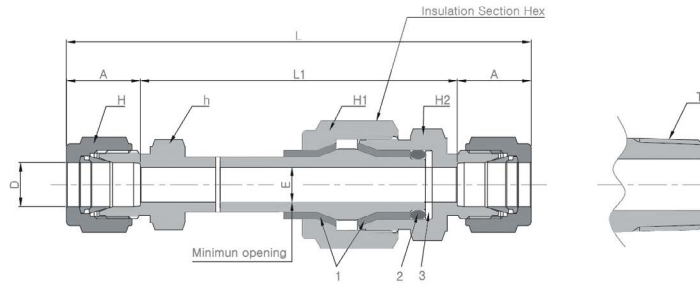

Materials & Technical Information

- Insulator: Molded Thermoplastic
- Standard O-ring & Back Up Ring : 90 Durometer FKM / Virgin PTFE for Temperature Rating of -40 to 200°F (-40 to 93°C)
- Optional Application : **Low Temperature Rating** of -76 to 200°F (-60 to 93°C)
- Pressure Rating: 4,000 psig (275 bar) @ 70°F (21°C)
- Electrical Resistance at 70°F(21°C): 10x10⁶Ω @ 10 Volts DC, voltage breakdown resistance 3,000 Volts DC.
- Body, Ferrules, Nuts: Stainless Steel 316

Ordering Information

To order, select Part Number listed below. Example : **DEU10M-S**
To order Low Temperature(-60C) application, Insert designator **-LT (Low Temperature)** into the basic Part Number.
Example: DEU10M-LT-S

Part No.	Tube O.D. D		Pipe Thread T(NPT)	E Min.		A	L	L1	Width across flat							
	in.	mm		in.	mm				h		H		H1		H2	
									in.	mm	in.	mm	in.	mm	in.	mm
DEU4	1/4	6.35		0.19	4.8	15.21	100.8	70.3	1/2	12.7	9/16	14.28	7/8	22.22	13/16	20.64
DEU6	3/8	9.52		0.28	7.1	16.78	104.3	70.8	5/8	15.87	11/16	17.46				
DEU8	1/2	12.7				22.85	110.9	65.2	13/16	20.6	7/8	22.22				
DEU10M		10.0				17.03	106.2	72.2		18		19				
DEU12M		12.0				21.84	109.4	65.7		22		22				
DEMC6-4N	3/8	9.52	1/4					16.87	99.72	-	5/8	15.87	11/16	17.46		
Special Internal Bore																
DEU8-E10M	1/2	12.7		10.0	22.84	111.4	65.7		20.64		22.22	1	25.4	7/8	22.22	
DEU6M-E4M		6.00		4.0	15.23	100.8	70.3		14		14	7/8	22.22	13/16	20.64	
DEU8M-E6M		8.00		6.0	16.00	104.20	72.20		15		16	7/8	22.22	13/16	20.64	
DEU10M-E8M		10.00		8.0	17.03	106.20	72.10		18		19	1	25.40		22	
DEU12M-E10M		12.00		10.0	21.84	109.42	65.73		22		22	1	25.40		22	
DEU14M-E10M		14.00		10.0	24.4	113.1	64.2		24		25	1	25.4		24	

Di-electric tube fitting is designed to apply where electrical current flowing through a pipe or tubing line must be interrupted to protect instruments.

Di-electric Tube fitting is commonly used in the natural gas transmission station where installed on impulse lines ahead of stations. This fitting interrupts cathodic current flow while permitting full fluid flow.

GAS TRANSMISSION TYPICAL APPLICATION

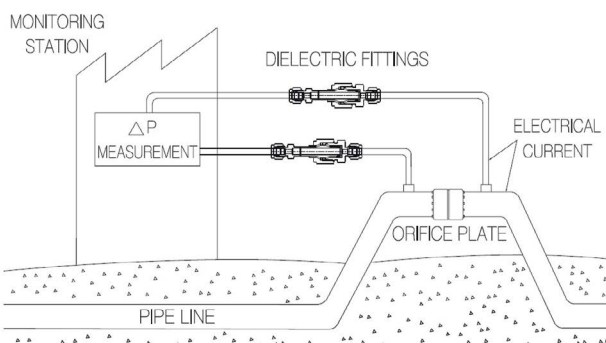

Function

- The insulation function is performed by thermoplastic insulators.
- FKM O-ring and PTFE back up ring provide fluid containment function within the fitting.
- DK-Lok twin ferrule system provides reliable sealing in the impulse line tubing.

Caution



CAUTION
DO NOT WRENCH THIS HEX
NOR DISASSEMBLE THIS CONNECTION

This “NO wrenching label” is placed on the insulation section hex. This insulation connection must not be disconnected.

Sanitary Fitting
DSFC

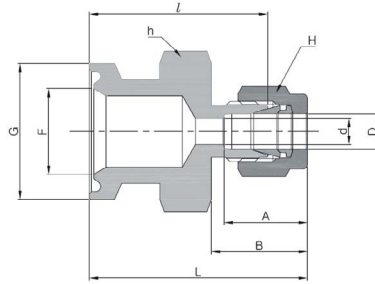

Part No.	Tube O.D.		Flange Size	d min.	Width across flat				A	B	F	G	ℓ	L
	D				h		H							
	in.	mm			in.	mm	in.	mm						
DSFC4-8SC	1/4	6.35	1/2	4.8	1	25.4	9/16	14.28	15.24	17.78	9.4	24.9	32.64	39.9
DSFC4-12SC	1/4	6.35	3/4	4.8	1	25.4	9/16	14.28	15.24	17.78	15.7	24.9	32.64	39.9
DSFC4-16SC	1/4	6.35	1	4.8	1-3/8	34.92	9/16	14.28	15.24	17.78	22.1	50.3	32.64	39.9
DSFC4-24SC	1/4	6.35	1 1/2	4.8	1-3/8	34.92	9/16	14.28	15.24	17.78	34.8	50.3	32.64	39.9
DSFC6-8SC	3/8	9.52	1/2	7.11	1	25.4	11/16	17.46	16.76	19.3	9.4	24.9	34.08	41.4
DSFC6-12SC	3/8	9.52	3/4	7.11	1	25.4	11/16	17.46	16.76	19.3	15.7	24.9	34.08	41.4
DSFC6-16SC	3/8	9.52	1	7.11	1-3/8	34.92	11/16	17.46	16.76	19.3	22.1	50.3	34.08	41.4
DSFC6-24SC	3/8	9.52	1 1/2	7.11	1-3/8	34.92	11/16	17.46	16.76	19.3	34.8	50.3	34.08	41.4
DSFC8-8SC	1/2	12.7	1/2	10.41	1	25.4	7/8	22.22	22.86	21.84	9.4	24.9	34.05	44.2
DSFC8-12SC	1/2	12.7	3/4	10.41	1	25.4	7/8	22.22	22.86	21.84	15.7	24.9	34.05	44.2
DSFC8-16SC	1/2	12.7	1	10.41	1-3/8	34.92	7/8	22.22	22.86	21.84	22.1	50.3	34.05	44.2
DSFC8-24SC	1/2	12.7	1 1/2	10.41	1-3/8	34.92	7/8	22.22	22.86	21.84	34.8	50.3	34.05	44.2
DSFC16-16SC	1	25.4	1	22.35	1-3/8	34.92	1-1/2	38.1	31.24	26.41	22.1	50.3	36.32	48.5
DSFC16-32SC	1	25.4	2	22.35	2-3/4	69.85	1-1/2	38.1	31.24	26.41	47.5	64	51.02	63.2

Chromatography Fitting
DCHU

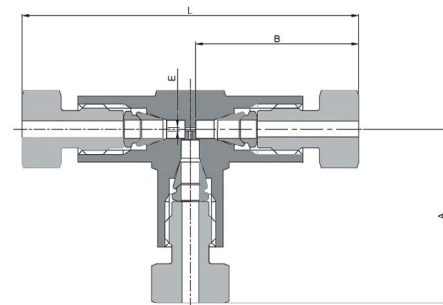
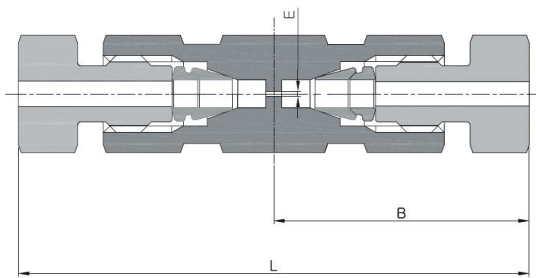

Materials & Technical Information

- Useable for gas or liquid chromatography
- Material is stainless steel 316
 - Bar stock: ASTM A276 TYPE316
 - Forging: ASTM A182 F316
- Available size are tube O.D 1/16

Ordering Information

To order, select part number listed below.

Part No.	Tube O.D.	E	A	B	L
DCHU-1	1/16	0.3 (0.012)	-	15.5 (0.61)	33.5 (1.32)
DCHT-1	1/16	0.3 (0.012)	16.75 (0.66)	15.5 (0.61)	33.5 (1.32)

Nut DN

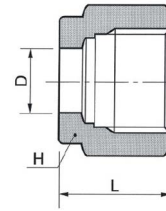

Fractional

Part No.	Tube O.D. D		With across flat H		L
	in.	mm	in.	mm	
DN-1	1/16	1.59	5/16	7.93	7.90
DN-2	1/8	3.17	7/16	11.11	11.93
DN-3	3/16	4.76	1/2	12.70	11.93
DN-4	1/4	6.35	9/16	14.28	12.70
DN-5	5/16	7.93	5/8	15.87	13.46
DN-6	3/8	9.52	11/16	17.46	14.22
DN-8	1/2	12.70	7/8	22.22	17.52
DN-10	5/8	15.87	1	25.40	17.52
DN-12	3/4	19.05	1-1/8	28.57	17.52
DN-14	7/8	22.22	1-1/4	31.75	17.52
DN-16	1	25.40	1-1/2	38.10	20.57
DN-20	1-1/4	31.75	1-7/8	47.63	31.75
DN-24	1-1/2	38.10	2-1/4	57.15	38.10
DN-32	2	50.80	3	76.20	52.32

Metric

Part No.	Tube O.D. D	With across flat H	L
DN-2M	2	12	11.90
DN-3M	3	12	11.90
DN-4M	4	12	11.90
DN-6M	6	14	12.70
DN-8M	8	16	13.50
DN-10M	10	19	15.10
DN-12M	12	22	17.40
DN-15M	15	25	17.40
DN-16M	16	25	17.40
DN-18M	18	30	17.40
DN-20M	20	32	17.40
DN-22M	22	32	17.40
DN-25M	25	38	20.60
DN-28M	28	46	30.60
DN-32M	32	50	34.40
DN-38M	38	60	40.60
DN-42M	42	65	40.60
DN-50M	50	76.2	52.60

Ferrule Set DFS



Fractional

Part No.	Tube O.D. D	
	in.	mm
DFS-1	1/16	1.59
DFS-2	1/8	3.17
DFS-3	3/16	4.76
DFS-4	1/4	6.35
DFS-5	5/16	7.93
DFS-6	3/8	9.52
DFS-8	1/2	12.70
DFS-10	5/8	15.87
DFS-12	3/4	19.05
DFS-14	7/8	22.22
DFS-16	1	25.40
DFS-20	1-1/4	31.75
DFS-24	1-1/2	38.10
DFS-32	2	50.80

Metric

Part No.	Tube O.D.
DFS-2M	2
DFS-3M	3
DFS-4M	4
DFS-6M	6
DFS-8M	8
DFS-10M	10
DFS-12M	12
DFS-14M	14
DFS-15M	15
DFS-16M	16
DFS-18M	18
DFS-20M	20
DFS-22M	22
DFS-25M	25
DFS-28M	28
DFS-30M	30
DFS-32M	32
DFS-38M	38
DFS-42M	42
DFS-50M	50

Nut-Ferrule Set DFSN



Fractional

Part No.	Tube O.D.
	in.
DFSN-1	1/16
DFSN-2	1/8
DFSN-3	3/16
DFSN-4	1/4
DFSN-5	5/16
DFSN-6	3/8
DFSN-8	1/2
DFSN-10	5/8
DFSN-12	3/4
DFSN-14	7/8
DFSN-16	1
DFSN-20	1-1/4
DFSN-24	1-1/2
DFSN-32	2

Metric

Part No.	Tube O.D.
DFSN-2M	2
DFSN-3M	3
DFSN-4M	4
DFSN-6M	6
DFSN-8M	8
DFSN-10M	10
DFSN-12M	12
DFSN-14M	14
DFSN-15M	15
DFSN-16M	16
DFSN-18M	18
DFSN-20M	20
DFSN-22M	22
DFSN-25M	25
DFSN-28M	28
DFSN-30M	30
DFSN-32M	32
DFSN-38M	38
DFSN-42M	42
DFSN-50M	50

Front Ferrule DFF

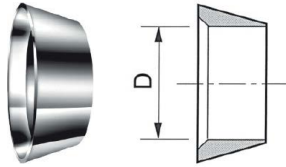

Fractional

Part No.	Tube O.D. D		Part No.	Tube O.D. D	
	in.	mm		in.	mm
DFF-1	1/16	1.59	DFF-10	5/8	15.87
DFF-2	1/8	3.17	DFF-12	3/4	19.05
DFF-3	3/16	4.76	DFF-14	7/8	22.22
DFF-4	1/4	6.35	DFF-16	1	25.40
DFF-5	5/16	7.93	DFF-20	1-1/4	31.75
DFF-6	3/8	9.52	DFF-24	1-1/2	38.10
DFF-8	1/2	12.70	DFF-32	2	50.80

Metric

Part No.	Tube O.D.	Part No.	Tube O.D.
DFF-2M	2	DFF-18M	18
DFF-3M	3	DFF-20M	20
DFF-4M	4	DFF-22M	22
DFF-6M	6	DFF-25M	25
DFF-8M	8	DFF-28M	28
DFF-10M	10	DFF-32M	32
DFF-12M	12	DFF-38M	38
DFF-15M	15	DFF-42M	42
DFF-16M	16	DFF-50M	50

Back Ferrule DFB

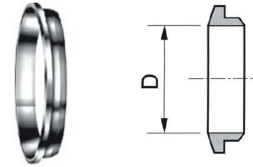

Fractional

Part No.	Tube O.D. D		Part No.	Tube O.D. D	
	in.	mm		in.	mm
DFB-1	1/16	1.59	DFB-10	5/8	15.87
DFB-2	1/8	3.17	DFB-12	3/4	19.05
DFB-3	3/16	4.76	DFB-14	7/8	22.22
DFB-4	1/4	6.35	DFB-16	1	25.40
DFB-5	5/16	7.93	DFB-20	1-1/4	31.75
DFB-6	3/8	9.52	DFB-24	1-1/2	38.10
DFB-8	1/2	12.70	DFB-32	2	50.80

Metric

Part No.	Tube O.D.	Part No.	Tube O.D.
DFB-2M	2	DFB-18M	18
DFB-3M	3	DFB-20M	20
DFB-4M	4	DFB-22M	22
DFB-6M	6	DFB-25M	25
DFB-8M	8	DFB-28M	28
DFB-10M	10	DFB-32M	32
DFB-12M	12	DFB-38M	38
DFB-15M	15	DFB-42M	42
DFB-16M	16	DFB-50M	50

Preswaging Tool DPS



Fractional DK-Lok

Part No.	Tube O.D.
DPS-4-C	1/4
DPS-5-C	5/16
DPS-6-C	3/8
DPS-8-C	1/2
DPS-12-C	3/4

Metric DK-Lok

Part No.	Tube O.D.
DPS-3M-C	3
DPS-6M-C	6
DPS-8M-C	8
DPS-10M-C	10
DPS-12M-C	12
DPS-16M-C	16
DPS-18M-C	18
DPS-20M-C	20

Operation Instructions

Pre-swaging Tool(DPS)

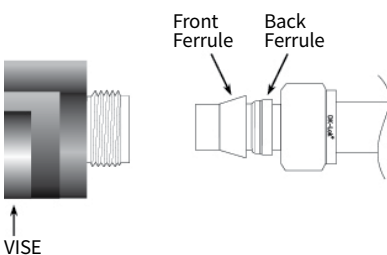

Assembly on Fitting

1. Insert the ferrules pre-swaged tubing into the fitting body until the front ferrule seats.
2. Hand-tighten the nut.
3. Wrench-tighten the nut to the previously pulled-up position; at this point, a sharp rise in torque is felt.
4. Tighten slightly with a wrench.

Operation on Pre-Swaging Tool

1. Clamp the DPS on the VISE steadily.
2. Install the DK-Lok nut, ferrules onto the tubing.
3. Insert the loose ferrules and loose nut installed tubing end into the DPS until it is bottomed on the shoulder of the DPS.
4. Finger-tighten the nut.
5. Scribe the nut at the 6 o'clock position.
6. Wrench-tighten the nut 1 1/4 turns to the 9 o'clock position.
 - Tighten the nut 3/4 turn to the 3 o'clock position for 1/16, 1/8, and 3/16 in.; 2, 3, and 4mm Tube Fittings.
7. Un-thread the nut.
8. Remove the tubing pre-swaged ferrules from the DPS.
 - In case the tubing is difficult to remove from DPS, gently rock the tubing back and forth. Do not rotate the tubing.

Gap Gauge DIG

This no-go gap gauge is useful tool to inspect the DK-Lok initially pulled-up.

Operation Instructions

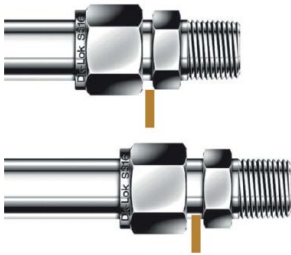

On initial assembly, apply DK-Lok no-go gap inspection gauge to make sure that the make-up distance is sufficiently pulled-up.

Refer to Fig 1.

1. The gap gauge does not fit the gap between the nut and the body hex. This ensures that the fitting is sufficiently tightened on initial assembly.

Refer to Fig 2.

2. The gap gauge fits the gap between the nut and the body hex. The fitting requires an additional tightening.

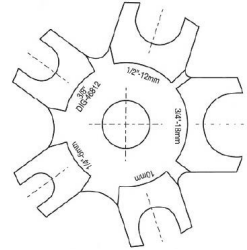

Part No.	Fitting Size	
	in	mm
DIG-46812	This gauge works on eight sizes	
	1/4, 3/8, 1/2, and 3/4.	6, 10, 12, and 18
DIG-5	5/16	-
DIG-12	3/4	-
DIG-16	1	25

Tube Depth Marking Tool

DTM

Marking on tubing prior to make-up with DK-Lok.



Operation Instructions

1. Insert tubing into DTM until it is bottomed on tool.
2. Mark the tube at the top of the DTM with a pen.
3. Remove the tube from the DTM and insert into DK-Lok fitting until it is bottomed on the shoulder of the fitting body.
4. If the marking can be seen above the fitting nut, it indicates the tube not fully bottomed inside the fitting.

Fractional

Part No.	Tube O.D. (in.)
DTM-4-C	1/4
DTM-6-C	3/8
DTM-8-C	1/2
DTM-10-C	5/8
DTM-12-C	3/4
DTM-16-C	1

Metric

Part No.	Tube O.D. (in.)
DTM-6M-C	6
DTM-8M-C	8
DTM-10M-C	10
DTM-12M-C	12
DTM-16M-C	16
DTM-25M-C	25

Units

Pre-Swaging



Hydraulic Swaging Unit
DHS-2A



Electric Swaging Unit
DES-1A

Pre-swaging DK-Lok ferrules onto tubing.

in.	1/2, 5/8, 3/4, 1, 1 1/4, 1 1/2, and 2.
mm	12, 14, 15, 16, 18, 20, 22, 25, 28, 30, 32, 38, 42 and 50.

Pre-swaging unit must be used to install 1 1/4, 1 1/2, and 2 in. and 28, 30, 32, and 38 mm fittings

Contact DK-Lok authorized distributor for operating manuals of DHA-2A and DES-1A

Hand Tube Bender

DHTB

DK-Lok hand tube benders provide consistent, high-quality bends in tubing made from materials that can be used with DK-Lok tube fittings.



Technical Information

- For 1/4" to 1/2" and 6mm to 12mm O.D. tubing.
- Accurate and tight bends up to 180° in stainless steel and other tough metals.
- Rollers reduce friction and bending effort; eliminate scoring of tubing.
- Vise lug for mounting in vise.
- Durable nickel nish.

Fractional

Part No.	Tube O.D. (in.)	Bend Radius (in.)
DHTB-4	1/4	9/16
DHTB-6	3/8	15/16
DHTB-8	1/2	1-1/2

Metric

Part No.	Tube O.D. (mm)	Bend Radius (mm)
DHTB-6M	6	15
DHTB-8M	8	24
DHTB-10M	10	24
DHTB-12M	12	38

Tube Cutter

DTC

DK-Lok tube cutter cuts stainless steel, soft copper, and tubing from 1/8 to 1 1/8 in. and 4 to 28mm outside diameter.



Technical Information

- Enclosed hardened steel, thrust bearing, feed mechanism for smoothest cutting action and trouble free operation.
- Rugged aluminum alloy body designed for handling ease.
- Body is hand buffed and nickel chrome plated to a high-luster nish.
- Rollers feature flare cut-off groove to reduce tube loss when damaged flare is removed.

Replacement Cutting Wheel Part No. : DTCW

Tube Deburring Tool

DTDT

After use of the tube cutter or tube sawing guide, DK-Lok deburring tools deburr stainless steel, steel, and hard alloy tube ends.

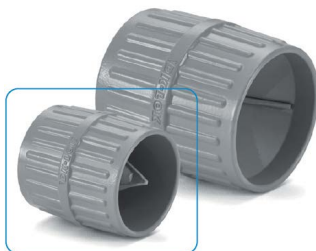

Technical Information

- For deburring inside and outside diameters of 3/16 to 1 1/2 in. and 4 to 38mm tubing.
- Tough die cast body.
- Steel blades for long life.
- Rugged, heavy-duty die-cast housing.

INSTALLATION INSTRUCTIONS

This instruction applies to DK-Lok Tube Fittings as well as DK-Lok Z series Tube Fittings. DK-Lok is supplied finger-tight and ready for immediate use. Therefore fitting disassembly is not necessary for installation.

Tube-end preparation

Prior to installation, make sure to have tube-end cut 90 degree, and remove burrs from inside and outside tube ends. Use proper tube cutter and maintain a sharp cutting wheel on it.

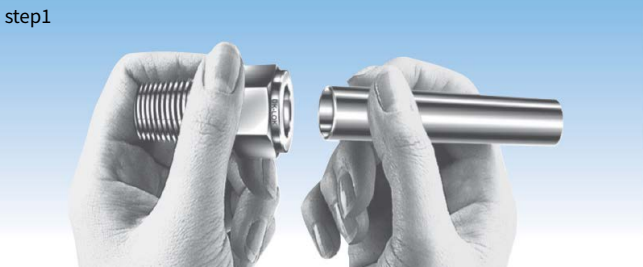

Insert the tubing into the DK-Lok tube fitting until the tubing end bottoms on the shoulder of the fitting body.

- Make sure the nut finger-tight

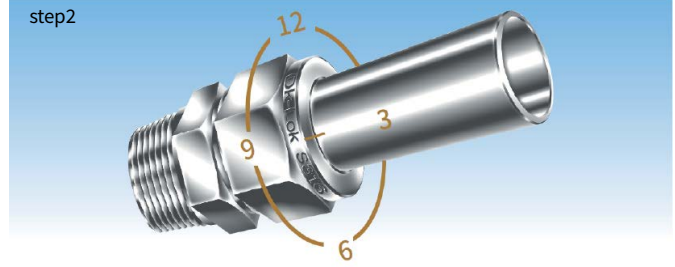

Scribe the nut at the 6 o'clock position and wrench-tighten the nut 1 1/4 turns to the 9 o'clock position, holding the body with a back up wrench.

- Tighten the nut 3/4 turn to the 3 o'clock position for 1/16, 1/8, and 3/16 in.; 2, 3, and 4mm Tube Fittings.

DK-Lok Installation for High Pressure or High Safety Applications

1. Insert tubing on the Dk-Lok tube fitting until the tubing end bottoms on the shoulder of the fitting body.
 2. Wrench-tighten the nut until the tubing does not rotate by hand or moves axially in the fitting.
 3. Scribe the nut at 6 o'clock position.
 4. Wrench-tighten the nut to the 9 o'clock position, holding the body with a back up wrench.
- Only 3/4 turn to the 3 o'clock position is required for 1/16, 1/8, and 3/16 in.; 2, 3 and 4mm Tube Fittings.

Inspection of Gaugeable Dk-Lok fitting initially pulled-up

DK-Lok Tube Fittings are gaugeable. This allows installer to inspect that the make-up distance is sufficiently pulled-up on initial assembly. Refer to page on 77 for Gap Gauge Operation Instructions. DK-Lok Gap Gauge is applicable to those Dk-Lok fittings made out of SS316, Carbon steel, Brass, and Exotic alloy materials

Re-Assembly Instructions

DK-Lok can be used many times. Prior to re-assembly, ensure the components are clean and free of defects.

1. Insert the ferrules swaged tubing into the body until the front ferrule seats firmly.
2. Hand-tighten the nut.
3. Wrench-tighten the nut to the previously pulled-up position; at this point, a sharp rise in torque is felt.
4. Tighten slightly with a wrench.

Tube handling during installation

Do not force the tubing into the fitting when it does not smoothly go in. It may be a deformed oval.

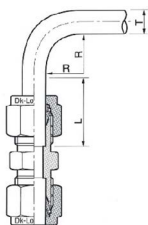

T : Tube O.D.
R : Radius
L : Straight tube length

In case tube bend is too close to a fitting, the bend section shall enter the fitting.

This may not allow the tube to be bottomed in the fitting, resulting in leaks.

Keep the proper straight length of tube as shown in the tables.

- Do not bend a tube in the fitting. Use tube bender prior to installation onto fitting.

Fractional tube, in.		Metric tube, mm	
T	L	T	L
1/16	1/2	3	19
1/8	23/32	6	21
3/16	3/4	8	23
1/4	13/16	10	25
5/16	7/8	12	31
3/8	15/16	14	32
1/2	13/16	15	32
5/8	11/4	16	32
3/4	11/4	18	32
7/8	15/16	20	34
1	11/2	22	34
1 1/4	2	25	40
1 1/2	2 13/32	28	46
2	3 1/4	30	50
		32	54
		38	63
		50	80



경상남도 김해시 주촌면 골든루트로 129번길 7 50969

7, Golden root-ro 129beon-gil, Juchon-myeon, Gimhae-si, Gyeongsangnam-do, South Korea. 50969

Tel. +82-55-338-0114 Fax. +82-55-901-0141 www.dklok.com
